



GRADY-WHITE 2009

Welcome to the Grady Life!

We are delighted that you recognize the quality of life that a Grady-White brings to you and your family!

Fifty years ago in an old warehouse in Greenville, NC, Glen Grady and Don White began crafting handsome, high quality, strongly built wood lapstrake boats with flared bows that were just perfect for the open, often rough waters of the Atlantic coast. Nine years later, Eddie Smith and his father purchased the company on a wing and a prayer, a true dedication to business integrity and customer satisfaction, plus a regard for teamwork and collaboration with boat owners. Today, in one of the world's most modern boatbuilding facilities, these core values and principles have been honed and refined by a powerful determination to create a great hand laid fiberglass product and a superb customer relationship. Backed by long-term associates, craftsmen, dealers and



company managers (all of whom are the industry's best), today's Grady-White boats bring families together and create priceless memories. When it comes to quality, safety, reliability, value and genuine satisfaction, a Grady-White is in a class by itself. It is the ultimate boating experience. Thanks for considering a Grady-White for you and your family. We hope you will visit your dealer today to learn so much more!



Eddie Smith, Chairman & CEO

Kris Carroll, President



Time flies, but your Grady Days memories will last forever.

For 50 years, Grady-White has delivered the highest levels of customer satisfaction. Look at the customer testimonials in this catalog.

Visit grady-white.com and view the Grady Life photos. Page through our *Anchorline* newsletters, and check the websites of Grady-White owners' clubs nationwide. Our customers love to share stories about their great Grady moments and how well their boats perform! These reflections are not the only benchmarks of owner enjoyment. Every third-party measure

"I can't say enough good things about my Grady dealership. They are complete professionals. I like their logic: you may have been boating for years but you've not been out on *this* boat so they spend the time to go over every detail."

—Melvin Cline, Chesapeake Beach, MD
Tournament 275 owner

conducted in our industry for our category has resulted in reports of Grady-White Boats providing the highest levels of customer satisfaction.

In each of the years that J.D. Power and Associates has conducted studies in the marine industry, Grady-White shines. This past model year, Grady-White was recognized "Highest in Customer Satisfaction with Coastal Fishing Boats Seven Times in a Row." No other builder of coastal boats has been

so ranked, even once. And, Grady has been top-ranked each year that the National Marine Manufacturers Association has compiled its Customer Satisfaction Index. That's seven times in a row, too. Behind each one of these very flattering rankings and awards are great dealers and happy customers making delightful memories. This experience is what great boating is all about.

Built to make memories and keep customers happy

Grady customers are happy as a result of the company's and our dealers' commitment to providing the ultimate boating experience. The values,

"Highest in Customer Satisfaction with Coastal Fishing Boats (17–30 feet) Seven Times in a Row"

Grady-White received the highest numerical score among coastal fishing boats (17-30 feet) in the proprietary J.D. Power and Associates 2001-2003, 2005-2008 Boat Competitive Information StudiesSM. 2008 study based on responses from 9,718 consumers measuring 13 coastal fishing boat brands and owner opinions of 2006 and 2007 model year boats registered June 2006-May 2007. Includes offshore coastal boats 17-30 feet with/without cabins, mostly outboard, some sterndrive power. Proprietary study results are based on experiences and perceptions of owners surveyed September-October 2007. Your experiences may vary. jdpower.com

principles and systems with which we've operated for 50 years, and the resulting product introductions, help ensure decades-long owner loyalty.

The physical qualities of the boats themselves provide product satisfaction. Features and controls, ride and handling, comfort and convenience, power and performance—all of these factors combine to deliver the on-the-water experience that our boat owners enjoy. Our dealers' product knowledge helps you select the model and configuration that best suit your boating style. Dealer service schools and service certification assure the maintenance capability that keeps your boat running reliably.

No doubt about it, the day-to-day, year-after-year Grady Life experience is pure fun!

The Grady Life

There are well over 100 annual Grady-White dealer events, tournaments, cruises and fishing schools enjoyed all over the country. A large and growing number of Grady-White clubs share camaraderie throughout the year. We publish a quarterly *Anchorline* newsletter by and for Grady owners, and there's an online resource center found at gradywhite.com.

The people at Grady-White really care about your having the best boating experience possible. The employees and associates of our privately held company—often with relationships that span our five decades—actively keep in touch with you to hear about your great Grady days, so you count on making many more special memories on the water with your family!





Grady-White: Historic highlights of a customer- and quality-focused company

50 years of quality, reliability, safety and performance: Why a Grady-White is really your family's best choice in a coastal boat.

Since day one back in 1959, Grady-White has built boats so solid, safe and reliable, and with such attention to detail, that the long-term cost of ownership is far lower than other brands. That's value! That's why Grady is the only real choice!

There is no other boat built like a Grady-White. Every Grady-White is a product of an unique combination of saltwater heritage, a dedication to safety, a culture of long-term private ownership, a keen knowledge of coastal family boating needs, and what is by far the closest relationship between company, dealers and customers in the marine industry. Through customer input, every boat is "Grady Built" to provide superior long-term value, safety and family enjoyment.

"Good enough" just isn't good enough at Grady-White. We sweat every detail to help ensure a more delightful boating experience. Details involve everything big or small, from the smallest screw to our huge, true self-bailing cockpits that move all incidental water overboard by gravity, not pumps. And safety? You won't find a boat with greater certified flotation properties than a Grady-White. Performance? Boat length for boat

length, the impressive—and exclusive—SeaV² hull designs deliver the best ride in boating, in any water condition and at any speed. Concentrating on all the details is an ingrained part of our company culture that has been honed by years of experience and careful listening to our customers. This all adds up to greater value!

Eddie Smith has owned Grady-White Boats since 1968. Our president, Kris Carroll, joined the company in 1975. Our talent-rich team's

total professional focus is on building premium quality sportfishing boats. We are dedicated, heart and soul, to our customers and to the superior safety, reliability, performance and dependability of our products. We employ many of the most skilled and likewise dedicated boat craftsmen in the world.

Through ongoing investments in our physical plant, Grady-Whites are built in the most complete and up-to-date fiberglass boat building in the world. Plus, the long-term relationships with our employees and dealerships support continuous product improvement.

Because your Grady-White is 100% solidly Grady-Built, the long-term cost of ownership is extraordinarily low compared to other brands. Tougher hardware holds up better and lasts longer. A superior structure and hull design not only ride softer and dryer, but lessen wear and tear. Every drink holder, every handhold, every feature, every square inch of storage, every detail is quality. No wonder a Grady-White commands top value in the used boat market when you're ready for your next Grady. That's long-term, long lasting value. No other brand compares!



22' GRADY-WHITE TOURNAMENT 2002 225hp 4-Stroke Yamaha, bimini top, Raytheon GPS, bow seating. Excellent condition. All service records. \$47,000

27' GRADY-WHITE CHASE 2005 Center console, Twin Yamaha, 150 hp, 52 hrs. Bow pulpit, anchor windless, T-top and curtains, depth finder. \$78,000

Just compare the resale values when you're shopping. Look at the used boats classifieds. You'll see that a well cared for Grady commands a better price than other boats in the same category.

1959

Glen Grady and Don White begin to build small, tough, high quality wooden "works of art" for coastal boating that performed even in rough seas.

1968

Inspired by the opportunity to invest in a tough, outdoor-oriented product, Eddie Smith purchases Grady-White and completes the changeover to fiberglass production.

1972

Eddie Smith, with his team of managers and associates at his side, breaks ground on what remains today one of the most modern boat manufacturing facilities in the world.

1975

Grady-White introduces the *Hatteras 204-C Overnighter*, the company's first walkaround, combining a center console's easy movement forward with the shelter of a cabin and canvas cover.

1982

The introduction of Grady-White's *Sailfish 25* ushers in the era of smaller outboard-powered sportfishing boats venturing far offshore.

1989

The *Marlin 28* introduces Grady-White's breakthrough SeaV² hull, a revolutionary design that delivers a soft, dry, true-tracking ride plus stability at lower speed.

1993

Grady-White's commitment to customer focus is renewed and strengthened as Eddie Smith chooses Kris Carroll, a Grady-White veteran, as Grady-White's new president.

2001

In J.D. Power and Associates' first study of the marine industry, Grady-White ranked "Highest in Customer Satisfaction with Center Console Boats."

2002

Grady-White's new flagship, the *Express 330*, is named *Boating Magazine's* Boat of the Year. Grady-White goes "Two for Two," ranked "Highest in Customer Satisfaction With Coastal Fishing Boats Two Years In A Row."

2003

A plant expansion begins a new era of Grady-White manufacturing; the world's most modern and completely integrated

boat building facility provides customers the benefits of efficiency and productivity in manufacturing with resulting quality and value. Grady-White ranked "Highest in Customer Satisfaction With Coastal Fishing Boats Three Years In A Row" by J.D. Power and Associates.

2005

Grady-White's newest flagship, the *Express 360*, is introduced. Chockfull of value and big boat features, the 360 sets a new benchmark for the boating industry. Grady-White is again ranked highest in customer satisfaction in its segment, named, "Highest in Customer Satisfaction With Coastal Fishing Boats Four Times in a Row" by J.D. Power and Associates.

2007

In January, Grady-White introduces the "ultimate coastal family boat," the *Tournament 275* dual console. In July, Grady-White introduces the *Express 305*, putting real big-boat express style features in a 30-foot package. In August, the company introduces the *Canyon 336*, a boat that incorporates cabin comfort in a fabulous center console package. The company is again awarded for superior customer satisfaction when ranked "Highest in Customer Satisfaction With Coastal Fishing Boats (17-28 feet) Six Times

in a Row." Grady continues to be recognized for excellence in customer satisfaction in every study conducted in the marine industry.

2008

Grady-White continues an unprecedented and unmatched string of highest customer satisfaction rankings in its segment in J.D. Power and Associates studies when ranked "Highest in Customer Satisfaction With Coastal Fishing Boats (17-30 feet) Seven Times in a Row." In July, for the 2009 model year, Grady-White introduces a great walkaround model, the *Chesapeake 290*, combining a roomy big boat-type cabin with a comfortable, easy to enjoy helm and cockpit area. Later in the year, Grady-White introduces another new dual console, the *Tournament 307*, with features the whole family will appreciate.

2009

Grady-White celebrates 50 years in business and an uninterrupted record of building high quality, safe, reliable and great performing boats that bring families together for great times on the water.



Grady-Built: The finest materials mean built-in value and security.



Our patented fold away aft bench seat is a result of our process of seeking customers' advice on the kinds of material and detail that work best. This means hardware and fixtures not only fit their function but that everything is placed right where you need it.

Our 316 grade stainless steel hardware initially costs more than the industry standard 304 grade because of the expensive nickel and chromium in the alloy, plus molybdenum. Cast parts are passivated in acid to remove casting impurities, then buffed, then passivated and buffed again. We test sample batches in our "instant ocean" salt bath. The result is hardware—such as our through-hull fittings—that's strong and durable even after years in a saltwater environment.



Whether we utilize a traditional glass laminate or a new composite or core material depends on the application. No matter which material we select, Grady-White's extensive in-house and on-the-water tests ensure long lasting value and low cost of ownership.

Cabins are handsome, with eye-pleasing, durable fabrics. We test appliances including microwaves, satellite radios, stereos and flat screen TVs and DVD players. Galley and head fixtures are the very best available.

RTM (Resin Transfer Molded) parts such as fish box lids, hardtops and bow pulpits are solid and durable. RTM is especially important for fish box lids because the smooth underside surface is easier to clean than the rough glass painted surfaces found on competitive products.

Gunwale mounted rod holders are chrome-over-bronze, which is impervious to UV rays and stronger than plastic.

Super strong and durable, polyethylene trim work and toe rails are tough for the long haul, plus they are low maintenance and their good looks last indefinitely.

Grab rails, handholds, handles, swim ladders and transom door latches are battleship-tough. Through-bolted cleats plus bow and stern eyes are made to Grady-White specifications. You get what you pay for with Grady: long lasting value. Years of trouble-free use and durable materials add up to a very low cost of ownership with excellent function and safety.



Built by craftsmen. Not only do we use the best, most proven materials available, we fit and finish our boats with unmatched precision. Compare. Take a close look. Grady-White workmanship is clearly superior.

Grady-Built: Built by craftsmen and superbly engineered through customer input



Our electromechanically operated electronics enclosures have dual functions. They lock up your valuable electronics, plus the height is adjustable so screens are easy to see in any light no matter how tall you are.

The people who design and engineer Grady-Whites are avid boaters themselves. Through ongoing contact with our boat owners, we create customer-driven designs that are thoroughly tested and constantly refined along the North Carolina coast to assure superb performance in the toughest conditions.

Hand laid fiberglass provides an unmatched laminate structure. Only 100% hand lay-up assures a uniform thickness for strength and structural stiffness. Grady-White uses this tried and true method, fitting patterned pieces of fiberglass to deliver consistent laminate thickness on every boat. The resin for every part is metered and measured so each has an optimal glass-to-resin ratio. Stringer systems are precision cut by computerized router and then glassed in while the hull is still in the mold so your SeaV² hull retains the correct shape. Our proven stringer grid system is consistently strong, light, phenomenally durable, and has a limited lifetime warranty. Closed cell foam sprayed in between the stringers adds strength and flotation.

Stringer systems are glassed into place while the hull is in its mold, ensuring your Grady holds its shape.



Our super strong transom is not only solidly Grady-Built of the strongest materials, but reinforced with an angled aluminum brace to provide sure support for today's four-stroke engines. This bracing supports the top motor hole mounts, distributing torque throughout the transom.

At the helm threshold of our cabin models, decks are joined to liners with double through bolting. Aft of the seat boxes, another through-bolted and fiberglassed system forms a "box grid" to secure the deck and liner together, giving Grady-Whites support not found in other boats. All adding up to lasting value!

Skilled craftsmen apply hand laid fiberglass with precisely the right thickness and resin ratios. Top quality components assembled with skill mean you get quality, reliability and performance over the long haul.



Our latest plant expansion began operation in 2003, making ours the most productive, efficient and completely integrated boatbuilding facility in the world today. This furthers the highest product quality and longest lasting value for you.



Every Grady-White offers comfort, safety and convenience.

1. The bow anchor locker is convenient for storage and allows quick access to the anchor for safety.

2. Lockable electronics or glove boxes are standard on most models.

3. Comfortable helm and companion seating. Our deluxe seating is fully adjustable for additional comfort.

4. Sound systems are available on most Grady-Whites. They are standard on our larger models.

5. Dry storage. Every Grady has plenty—just what you need for towels, extra clothing and personal items.

6. Drink holders are everywhere you need them. Convenient, and fewer slippery spills for safety!

7. Storage net is easy to use and great for stowing lots of items.

8. An enclosed head is a real surprise on smaller boats. All Grady-Whites over 21' (and several 20' models) offer a head or head option—a great comfort for all-day adventures.

9. Toe rails are easy to maintain and provide safety when you lean over the gunwale.

10. Horizontal rod racks and rod holders. Room for plenty of rods on every Grady-White. Cabin models often have additional rod racks.

11. Patented fold away aft seating is available on many models, opening up more cockpit room. Big cockpits are a Grady-White feature.

12. Grady-White's nonskid surfaces are everywhere you step and the design is proven reliable.

13. Cutting boards and rigging areas are located on most models.

14. Insulated ice boxes, fish boxes and sinks drain directly overboard by gravity on every Grady-White.

15. Handholds are where you naturally reach.



Step aboard a Grady and notice the high gunwales. These provide safety when you lean out over the water and are a real assurance when seas are rough.

Grady-Built: Safe and secure— The Grady-White difference

Safety first. There is no more important issue in boat building than your security. So at Grady-White, we “overbuild” and “overdo” every detail. The sea does not compromise, and neither do we. Every Grady-White we deliver is National Marine Manufacturers Association (NMMA) product certified and accessories are NMMA type accepted. This demonstrates adherence to applicable American Boating and Yachting Council (ABYC) standards. All models are available with optional CE certification, required for recreational boats sold in the European Union.



Every Grady-White is unsinkable. Check the certification tag on a Grady-White and you'll see either level or basic flotation.

Flotation properties are required on boats under 20 feet but not required on larger boats. While some competitive boats claim to be foam filled, they often don't have enough for basic flotation.

Grady-White's closed cell polyurethane foam provides unsurpassed flotation, adds strength and deadens sound. Every Grady-White is unsinkable. Our commitment to your safety is the highest priority at Grady-White.

Our boats have more than enough foam to keep the boat, motor and listed capacity of people afloat.

Grady-White's sprayed in closed cell polyurethane foam won't absorb water even if the hull is punctured, so the boat does not sink. The foam adheres to the stringers and hull and thus deadens sound and provides a solid feel.

The NMMA Certified label on a Grady-White lets you know that it was built to meet, and often exceed, quality and safety standards established by the U.S. Coast Guard and the ABYC. These standards include 33 categories covering electrical systems, powering, flotation, fuel systems and navigation lights. Certified boats must also pass rigorous annual inspections from independent third-party inspectors. As a result, U.S. Coast Guard statistics show NMMA Certified boats have far fewer recalls due to safety issues than non-certified boats.

The certification tags tell the story. Although flotation properties are not required for boats 20' and over, every Grady-White provides either level or basic flotation.



For your family's safety, there is no better choice than a Grady-White. Proven nonskid surfaces, wide walkarounds, grab rails and handholds are all part of your Grady's lasting value.



Look carefully at a Grady-White running. You can actually see three wakes coming off the hull. This is a reflection of the smooth and dry trademark Grady-White ride.

Often imitated but never equaled, there is no ride like Grady-White's. A Grady-White exclusive SeaV² hull offers the industry's best combination of seakeeping, dryness, performance and speed. Grady-White factory rigs four-stroke engines exclusively so the SeaV² hull is especially well balanced for the optimum performance of these new power sources. Unlike other brands, a SeaV² hull design has no two places on the keel where the deadrise is the same. The

vee continuously sharpens from the transom to the bow stem. A SeaV² hull design with 20 degrees of deadrise at the transom will have around 30 degrees amidships—more than even the most radical older deep vee designs. The deeper vee forward means a softer ride at sea. Less vee at the transom coupled with wide chines provide stability at rest and when trolling.

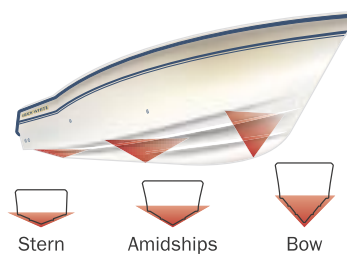

Like a series of sea-cutting wedges

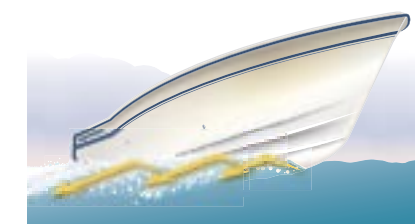

Strakes and chines knock down spray.

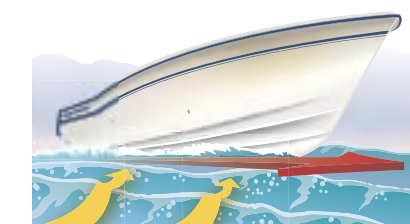

Tracks in quartering seas

Grady-Built: The ultimate offshore design— Grady-White exclusive SeaV² hulls

A SeaV² hull tracks as if the boat is on rails. The series of wedges that form a SeaV² hull have tremendous righting force providing incredible tracking in quartering seas and especially in following seas. There are no rounded shapes to behave like a ball in the water that knows no upright position.

Strakes and chines knock the spray down cold. Check the spray coming off a SeaV² hull. You can actually see three bow wakes in smooth water. Those are the individual deflectors working. This is the reason SeaV² hulls are drier running than boats with rounded sections that blow spray past the strakes and chines and into the cockpit.

Grady-White delivers a deep vee ride with modified vee efficiency. Unlike other deep vee hulls, SeaV² hulls provide a soft ride without fuel efficiency loss. A SeaV² hull slices through seas effortlessly with a sharp point of entry, and the varying deadrise builds buoyancy that lifts the boat as it proceeds through waves. The result: better performance.

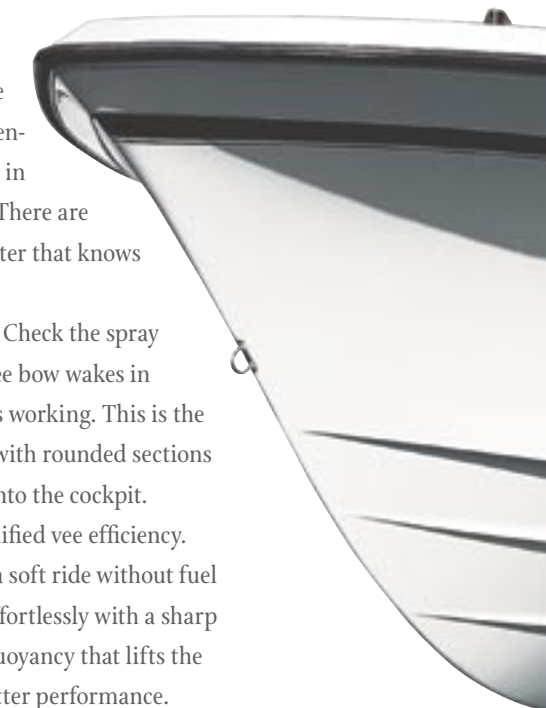

A sharp point of entry and a continuously variable deadrise down to a flatter stern mean wave cutting at speed and stability at rest.

Reach out in a Grady-White and you are likely to find a handhold just where you need one. Customer input and our own hands-on testing guide our placement of strategically located grab rails.

50th anniversary edition

Sportsman 180

18' CENTER CONSOLE

"We caught the biggest flounder aboard our *Sportsman 180*! We've caught plenty of fish and crab, but this was a beauty. Just like our boat."

—MARY M. THOMAS, AVALON, NJ *SPORTSMAN 180* OWNER

Beam Amidships: 7'5" (2.26 m)
Bridge Clearance: 5'7" (1.70 m)
Center Line Length: 17'10" (5.44 m)
Cockpit Depth: 22" (0.56 m)
Cockpit Square Footage: 48 sq. ft. (4.5 m²)
Hull Draft: 15" (0.38 m)

Maximum HP: 150 (112 kW)
Outboard Shaft Length: 25" (0.64 m)
Standard Fuel Capacity: 60 gal. (227 l)
Transom Width: 7'2" (2.18 m)
Weight w/o Engine: 2150 lb. (975kg)

For detailed specifications see page 51.

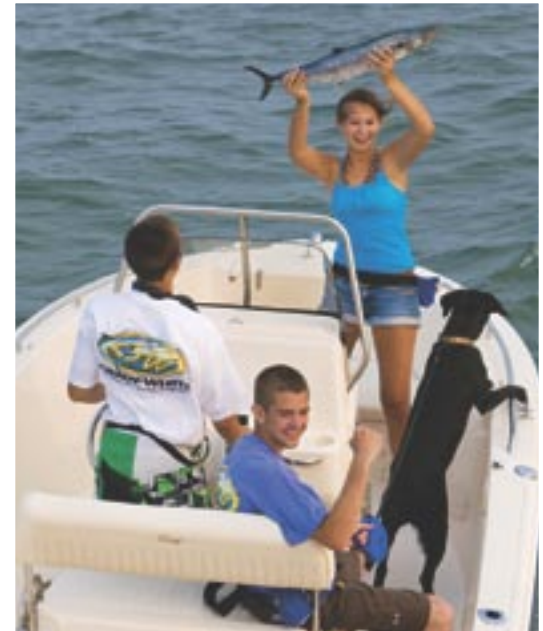
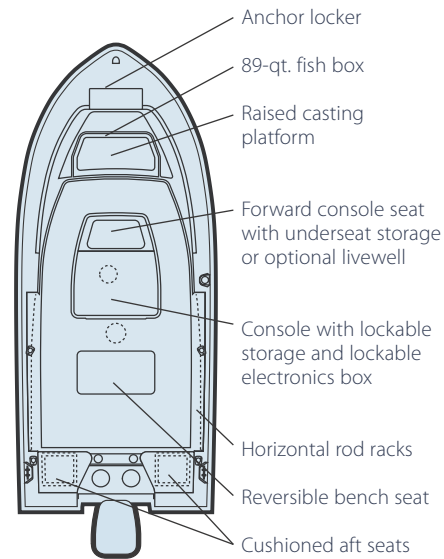

Console with flush mount electronics area



Bow fish box



Forward console with seating and bow anchor locker



Bow casting platform

50th anniversary edition

Tournament 185

18' DUAL CONSOLE

“Our *Tournament 185* is the best purchase we have ever made! Whether we are fishing or cruising, we appreciate the comfortable ride and well-built hull.”

—MEAGHAN AND GAVIN O'DAY, BELMAR, NJ *TOURNAMENT 185* OWNERS

Beam Amidships: 7'5" (2.26 m)
Bridge Clearance: 5'1" (1.55 m)
Center Line Length: 17'10" (5.44 m)
Cockpit Depth: 21" (0.53 m)
Cockpit Square Footage: 42 sq. ft. (3.9 m²)
Hull Draft: 15" (0.38 m)

Maximum HP: 150 (112 kW)
Outboard Shaft Length: 25" (0.64 m)
Standard Fuel Capacity: 60 gal. (227 l)
Transom Width: 7'2" (2.18 m)
Weight w/o Engine: 2250 lb. (1021 kg)

For detailed specifications see page 51.

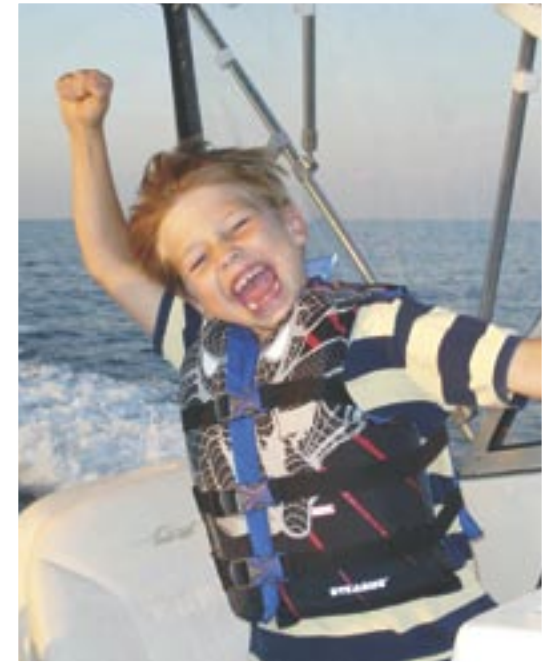
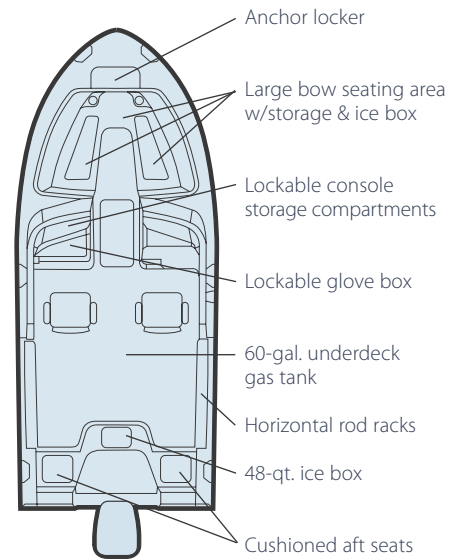

Starboard console storage



Port console storage



Helm station



Bow seating with optional forward bolsters

50th anniversary edition

Tournament 205

20' DUAL CONSOLE

"I absolutely love my boat. It's versatile, great for fishing out on the open water of the Georgian Bay here in Ontario and great for pike fishing in shallow water, too. Great for the family—we pack a picnic, go tubing out on the lake, then anchor and take a swim and relax."

—JOHN WELSH, POINTE AU BARIL, ONTARIO, TOURNAMENT 205 OWNER

Beam Amidships: 8'1" (2.46 m)
 Bridge Clearance: 5'7" (1.70 m)
 Center Line Length: 20'4" (6.20 m)
 Cockpit Depth: 25" (0.64 m)
 Cockpit Square Footage: 47 sq. ft. (4.4 m²)
 Hull Draft: 15" (0.38 m)

Maximum HP: 250 (187 kW)
 Outboard Shaft Length: 25" (0.64 m)
 Standard Fuel Capacity: 82 gal. (310 l)
 Transom Width: 7'10" (2.39 m)
 Weight w/o Engine: 2810 lb. (1275 kg)

For detailed specifications see page 51.

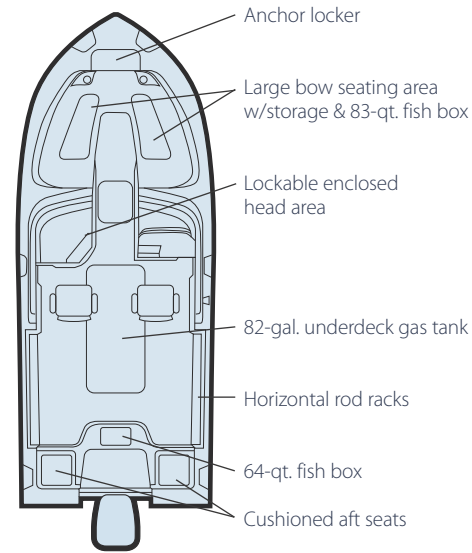

Cockpit forward with optional port sleeper seat and cockpit bolsters



Lockable enclosed head area with storage nets



Helm station



Forward seating with insulated ice box

50th anniversary edition

Adventure 208

20' WALKAROUND CABIN

"I fish offshore from harbors in the San Francisco Bay area and north from Bodega Bay, and I've taken my family water skiing and tubing in Lake Tahoe. Thanks for building such a versatile and safe boat."

—MICHAEL FISHER, BENICIA, CA ADVENTURE 208 OWNER

Beam Amidships: 8'1" (2.46 m)
 Bridge Clearance: 5'9" (1.75 m)
 w/Hardtop: 8' (2.44 m)
 Center Line Length: 20'4" (6.20 m)
 Cockpit Depth: 25" (0.64 m)
 Cockpit Square Footage: 41 sq. ft. (3.8 m²)

Hull Draft: 15" (0.38 m)
 Maximum HP: 250 (187 kW)
 Outboard Shaft Length: 25" (0.64 m)
 Standard Fuel Capacity: 82 gal. (310 l)
 Transom Width: 7'10" (2.39 m)
 Weight w/o Engine: 2900 lb. (1315 kg)

For detailed specifications see page 52.

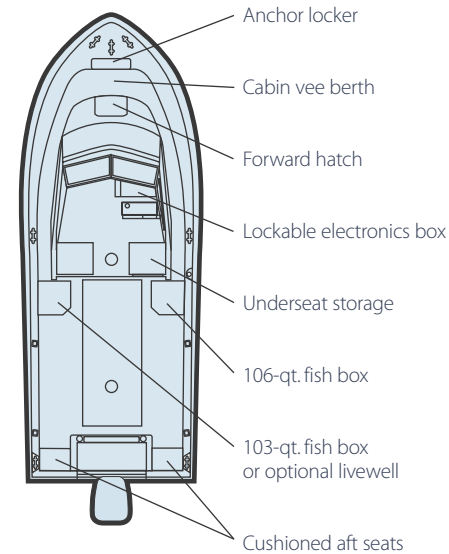

Cockpit forward with optional cockpit bolsters



Cabin interior shown without auxiliary berth cushions



Cushioned aft seating



Helm station with lockable electronics box

50th anniversary edition

Escape 209

20' CENTER CONSOLE

"My six-year-old son caught his first albacore on our *Escape 209*. Needless to say he was very excited."

—JAMES MOTT, SAN ANSELMO, CA *ESCAPE 209* OWNER

Beam Amidships: 8'1" (2.46 m)

Bridge Clearance: 5'9" (1.75 m)

w/T-top: 7'8" (2.34 m)

Center Line Length: 20'4" (6.20 m)

Cockpit Depth: 25" (0.64 m)

Cockpit Square Footage: 51 sq. ft. (4.7 m²)

Hull Draft: 15" (0.38 m)

Maximum HP: 250 (187 kW)

Outboard Shaft Length: 25" (0.64 m)

Standard Fuel Capacity: 82 gal. (310 l)

Transom Width: 7'10" (2.39 m)

Weight w/o Engine: 2600 lb. (1179 kg)

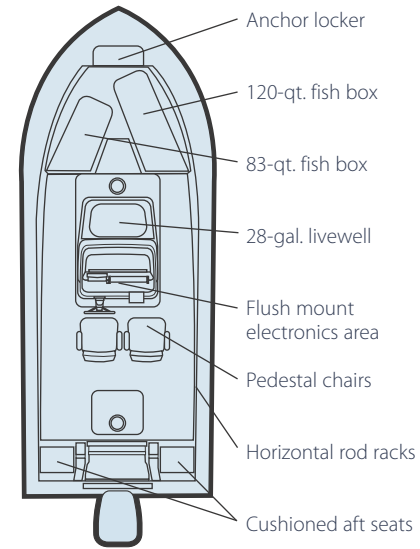

Insulated bow fish boxes with overboard drains



Aft cockpit with fold down motorwell bulkhead



Optional T-top and lean bar with tackle and bulk storage and flush mount electronics area

50th anniversary edition

Fisherman 222

22' CENTER CONSOLE

“What a wonderful boat. We just love it! We got the 222 for my wife and kids to do everything from fishing off North Carolina to crabbing in the Chesapeake. The ride and handling are just amazing!”

—STEVE WANN, ST. MICHAELS, MD, FISHERMAN 222 OWNER

Beam Amidships: 8' (2.44 m)

Bridge Clearance: 6'2" (1.88 m)

w/T-top: 8' (2.44 m)

Center Line Length: 22'2" (6.76 m)

Cockpit Depth: 25" (0.64 m)

Cockpit Square Footage: 55 sq. ft. (5.1 m²)

Hull Draft: 16" (0.41 m)

Maximum HP: 250 (187 kW)

Outboard Shaft Length: 25" (0.64 m)

Standard Fuel Capacity: 96 gal. (363 l)

Transom Width: 7'11" (2.41 m)

Weight w/o Engine: 3160 lb. (1433 kg)

Shown with optional T-top. For detailed specifications see page 52.

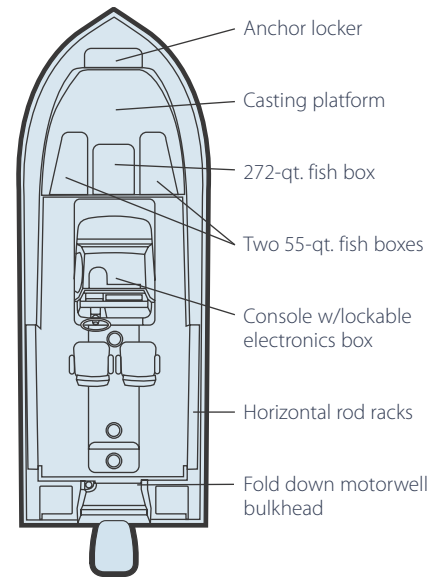

Aft cockpit with fold down motorwell bulkhead and optional cockpit bolsters



Helm station with lockable electronics box



Insulated bow fish boxes with overboard drains

50th anniversary edition

Tournament 225

22' DUAL CONSOLE

"I have all the confidence in the world in my boat, my dealer and Grady-White! We'll load the grandkids and take a ride to Blackbeard Island for a great day at the coast. My 225 has kept me safe in seven-foot waves and yet it's also great exploring the backwaters here in South Georgia."

—MIKE FLY, SOUTHERLAND BLUFF, GA TOURNAMENT 225 OWNER

Beam Amidships: 8' (2.44 m)

Bridge Clearance: 5'6" (1.68 m)

Center Line Length: 22'2" (6.76 m)

Cockpit Depth: 25" (0.64 m)

Cockpit Square Footage: 49 sq. ft. (4.6 m²)

Hull Draft: 16" (0.41 m)

Maximum HP: 250 (187 kW)

Outboard Shaft Length: 25" (0.64 m)

Standard Fuel Capacity: 96 gal. (363 l)

Transom Width: 7'11" (2.41 m)

Weight w/o Engine: 3450 lb. (1565 kg)

For detailed specifications see page 52-53.

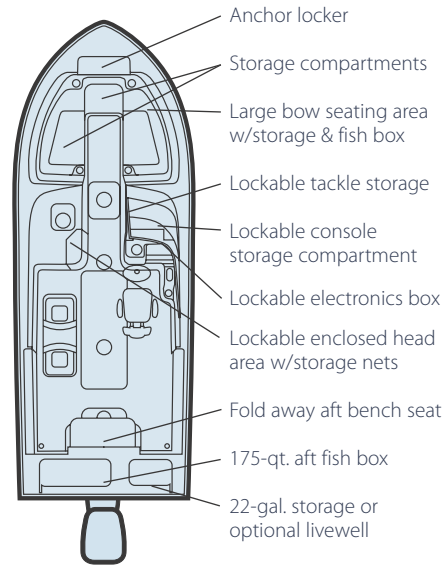

Bow area with optional sun platform with cushion



Transom with fold away bench seat, fish box and optional livewell



Lockable enclosed head area with storage nets



Cockpit forward with optional port sleeper seat and cockpit bolsters

50th anniversary edition

Seafarer 226/228

22' WALKAROUND CABIN

"I now fully understand the difference in quality and ride from other boats. The built-in livewell and fish boxes are great on my 228."

—TIM LEBLANC, CHAUVIN, LA SEAFARER 228 OWNER

Beam Amidships: 8' (2.44 m)
 Bridge Clearance: 62" (1.88 m)
 w/Hardtop: 84" (2.54 m)
 Center Line Length: 22'2" (6.76 m)
 Cockpit Depth: 26" (0.66 m)
 Cockpit Square Footage: 49 sq. ft. (4.6 m²)
 Hull Draft: 16" (0.41 m)

Maximum HP: 250 (187 kW)
 Outboard Shaft Length: 25" (0.64 m)
 Standard Fuel Capacity: 125 gal. (473 l)
 Transom Width: 7'11" (2.41 m)
 Weight w/o Engine:
 226 (standard transom): 3385 lb. (1535 kg)
 228 (Grady Drive transom): 3510 lb. (1592 kg)

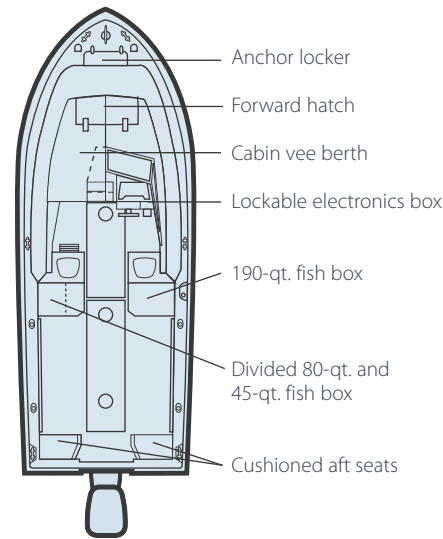

Shown with optional foredeck cushions. For detailed specifications see page 53.



Helm station with lockable electronics box



Cabin interior shown with auxiliary berth cushions



Grady Drive cockpit aft with optional bolsters (228)



Cabin access forward between helm and companion seats

50th anniversary edition

Gulfstream 232

23' WALKAROUND CABIN

“Our 232 is our second Grady and exceeds every expectation. We fish up to 50 miles offshore with total confidence and cruise Charleston Harbor with every comfort and convenience. Wide, roomy, safe and seaworthy—this is a terrific boat.”

—PAT AND MIKE OBSTFELD, MOUNT PLEASANT, SC GULFSTREAM 232 OWNERS

- | | |
|--|--|
| Beam Amidships: 9'3" (2.82 m) | Outboard Shaft Length |
| Bridge Clearance: 6'5" (1.96 m) | Single: 25" (0.64 m) |
| w/Hardtop: 8'8" (2.64 m) | Single w/F350: 30" (0.76 m) |
| Center Line Length: 23'5" (7.14 m) | Dual: 25" (0.64 m) |
| Cockpit Depth: 27" (0.69 m) | Standard Fuel Capacity: 150 gal. (568 l) |
| Cockpit Square Footage: 56 sq. ft. (5.2 m ²) | Transom Width: 8'10" (2.69 m) |
| Hull Draft: 20" (0.51 m) | Weight w/o Engine |
| Maximum HP: 400 (298 kW) | 232S: 4538 lb. (2058 kg) |
| For detailed specifications see page 53. | 232D: 4605 lb. (2089 kg) |

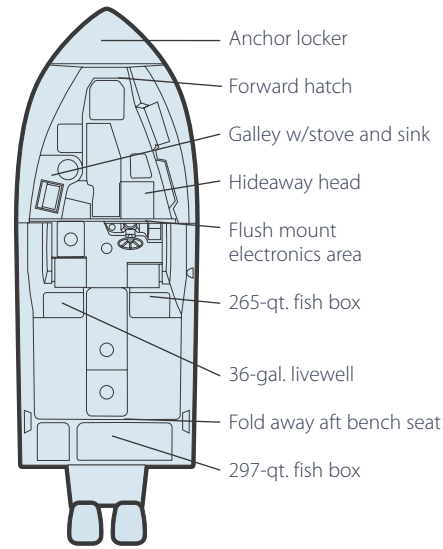

Shown with optional hardtop



Gulfstream 232



Cockpit forward with optional Deluxe II helm chairs



Cabin interior shown without auxiliary berth cushions



Head area in lockable cabin, with fold down cover; optional electric marine head shown



Fold away aft bench seat



Helm station with electronics flush mount area

50th anniversary edition

Advance 257

25' CENTER CONSOLE

“My son Rich and I had another banner summer offshore with our 257. We ventured off Montauk and hooked a 192-pound thresher shark. Thank goodness for the transom door!”

—MIKE GASPARIAN, FORT COLLINS, CO ADVANCE 257 OWNER

Beam Amidships: 8'6" (2.59 m)

Bridge Clearance: 7' (2.13 m)

w/T-top: 8'6" (2.59 m)

Center Line Length: 24'9" (7.54 m)

Cockpit Depth: 27" (0.69 m)

Cockpit Square Footage: 64 sq. ft. (5.9 m²)

Hull Draft: 20" (0.51 m)

Maximum HP: 350 (261 kW)

Outboard Shaft Length

Single: 30" (0.76 m)

Dual: 25" (0.64 m)

Standard Fuel Capacity: 151 gal. (572 l)

Transom Width: 7'10" (2.39 m)

Weight w/o Engine: 4045 lb. (1835 kg)

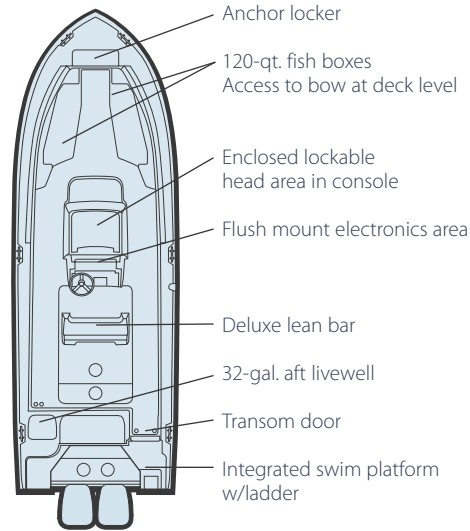

Shown with optional T-top. For detailed specifications see page 54.

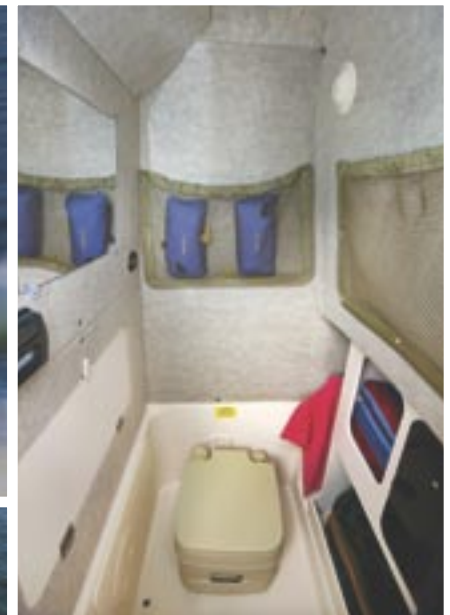

Helm with flush mount electronics area



Deluxe lean bar w/footrest, backrest and fold down bolster



Bow seating w/insulated storage

Lockable stand up console head enclosure w/storage shelves and hanging locker; shown with optional portable head

50th anniversary edition

Journey 258

25' WALKAROUND CABIN

“My 258 is fantastic for tuna fishing in the Otranto Channel, where weather conditions can change quickly. I have confidence in the safety and seaworthiness of my boat.”

—FEDERICO ERRICO, BARI, ITALY JOURNEY 258 OWNER

Beam Amidships: 8'6" (2.59 m)

Bridge Clearance: 6'6" (1.98 m)

w/Hardtop: 8'8" (2.64 m)

Center Line Length: 24'9" (7.54 m)

Cockpit Depth: 27" (0.69 m)

Cockpit Square Footage: 55 sq. ft. (5.1 m²)

Hull Draft: 20" (0.51 m)

Maximum HP: 350 (261 kW)

Outboard Shaft Length

Single: 30" (0.76 m)

Dual: 25" (0.64 m)

Standard Fuel Capacity: 127 gal. (481 l)

Transom Width: 7'10" (2.39 m)

Weight w/o Engine: 4320 lb. (1960 kg)

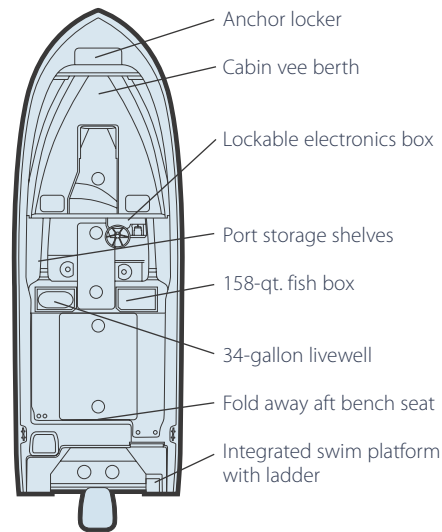

Shown with optional hardtop. For detailed specifications see page 54.



Helm station with lockable electronics box



Aft cockpit with insulated box and cockpit shower



158-qt. starboard insulated fish box with overboard drain



Cabin interior shown with auxiliary berth cushions

Chase 273

27' CENTER CONSOLE

"My Chase 273 is my third Grady-White. I fish on Long Island Sound and Naragansett Bay for stripers, fluke—whatever is biting. What I enjoy the most is that it is so easy to use whether fishing, cruising with the family, or maneuvering around the dock."

—THOMAS ELES, STAMFORD, CT CHASE 273 OWNER

- | | |
|--|--|
| Beam Amidships: 8'6" (2.59 m) | Maximum HP: 500 (373 kW) |
| Bridge Clearance: 6'9" (2.06 m) | Outboard Shaft Length |
| w/T-top: 8'3" (2.51 m) | Single: 30" (0.76 m) |
| Center Line Length: 26'11" (8.20 m) | Dual: 25" (0.64 m) |
| Cockpit Depth: 27" (0.69 m) | Standard Fuel Capacity: 205 gal. (776 l) |
| Cockpit Area: 65 sq. ft. (6.0 m ²) | Transom Width: 7'10" (2.39 m) |
| Hull Draft: 20" (0.51 m) | Weight w/o Engine: 4843 lb. (2197 kg) |

Shown with optional T-top. For detailed specifications see page 54-55.

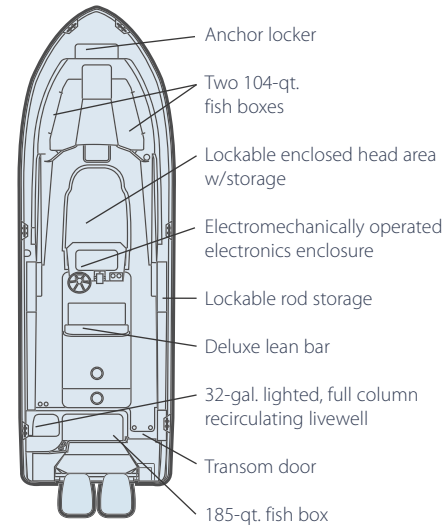

Lockable rod storage under gunwales keeps rods secure and safe



Bow fish boxes convert to bow seats (optional casting platform insert available)



Fold away aft bench seat, livewell, 185-qt. fish box and transom door



Helm console with electromechanically operated lockable electronics enclosure



50th anniversary edition

Tournament 275

27' DUAL CONSOLE

"I've been boating all my life, and the 275 is the greatest boat I've ever owned. The layout is absolutely perfect for someone who enjoys pleasure cruising, fishing and taking the kids tubing and skiing. The stability and responsiveness are amazing."

—MELVIN CLINE, CHESAPEAKE BEACH, MD TOURNAMENT 275 OWNER

Beam Amidships: 8'6" (2.59 m)	Maximum HP: 500 (373 kW)
Bridge Clearance: 6'3" (1.91 m)	Outboard Shaft Length
Bridge Clearance w/Hardtop: 8'6" (2.59 m)	Single: 30" (0.76 m)
Center Line Length: 26'11" (8.20 m)	Dual: 25" (0.64 m)
Cockpit Depth: 27" (0.69 m)	Standard Fuel Capacity: 200 gal. (757 l)
Cockpit Square Footage: 60 sq. ft. (5.6 m ²)	Transom Width: 7'10" (2.39 m)
Hull Draft: 20" (0.51 m)	Weight w/o Engines: 4972 (2255 kg)

Shown with optional hardtop. For detailed specifications see page 55.

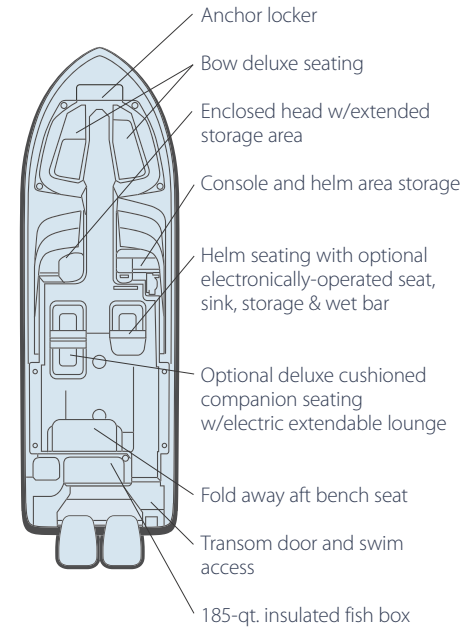

Cockpit shown with optional port electric extendable lounge seating



Deluxe cushioned bow seating with table (doubles as cockpit area table)



Aft fold away bench seating, 185-qt. insulated fish box, 32-gal. insulated cooler or livewell



Tournament 275

Release 283

28' CENTER CONSOLE

"The 283 is my sixth Grady-White. I wanted a fast boat to reach the Keys but not something too big. The 283 is a perfect combination of a long range boat for the open water and one that my wife and I can take out every day for cruising. I looked at two other makes, but Grady had the best handling, level of quality and solid engineering."

—REESE KAUFFMAN, SANIBEL, FL RELEASE 283 OWNER

- Beam Amidships: 9'6" (2.90 m)
- Bridge Clearance: 7'7" (2.31 m)
- w/T-top: 9' (2.74 m)
- Center Line Length: 28' (8.53 m)
- Cockpit Depth: 27" (0.69 m)
- Cockpit Square Footage: 69 sq. ft. (6.4 m²)
- Hull Draft: 20" (0.51 m)
- Maximum HP: 600 (448 kW) w/V6 engines only
- Outboard Shaft Length: 25" (0.64 m)
- Standard Fuel Capacity: 205 gal. (776 l)
- Transom Width: 9' (2.74 m)
- Weight w/o Engines: 5864 lb. (2660 kg)

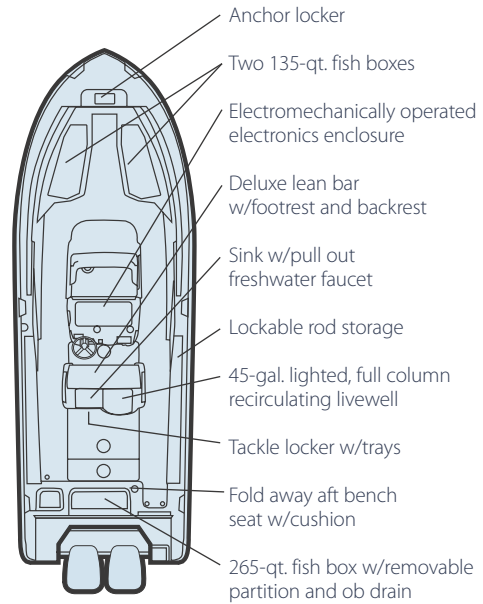

Shown with optional T-top. For detailed specifications see page 55.



Lockable head enclosure with fold down cover, sink and storage



Deluxe lean bar rigging station with livewell, tackle storage and freshwater sink



Helm console with electromechanically operated lockable electronics enclosure



50th anniversary edition

Chesapeake 290

29' WALKAROUND CABIN

"The spacious and comfortable cockpit, cabin and helm areas, plus the great visibility of the protective windshield, makes this a super and safe investment for families who enjoy spending time on the water."

—JOEY WELLER, GRADY-WHITE VICE PRESIDENT OF SALES AND MARKETING

- Beam Amidships: 9'11" (3.02 m)
- Bridge Clearance w/Hardtop: 9'9" (2.97 m)
- Center Line Length: 28' 6" (8.69 m)
- Length Overall (w/bow roller): 29' 9" (9.07 m)
- Cockpit Depth: 28" (0.71 m)
- Cockpit Square Footage: 56 sq. ft. (5.2 m²)
- Hull Draft: 24" (0.6 m)
- Maximum HP: 600 hp (448 kW)
- Outboard Shaft Length: 25" (0.64 m)
- Standard Fuel Capacity: 206 gal. (780 l)
- Transom Width: 9'1" (2.76 m)
- Weight w/o Engines: 7650 lb. (3470 kg)

Shown with optional hardtop-mounted rod holders. For detailed specifications see page 56.

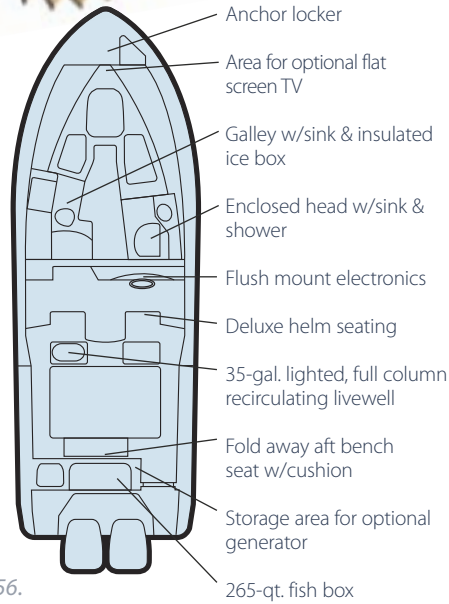

Fold away aft bench seat



Helm with flush mount electronics



Easy access for optional generator



Cabin interior with teak and holly sole and galley



Chesapeake 290

50th anniversary edition

Marlin 300

30' WALKAROUND CABIN

"Since we've owned our *Marlin 300*, my husband Alan has caught four tuna, the largest being 150 pounds. This boat brings him lots of luck!"

—PAM MURRAY, GLOUCESTER, MA *MARLIN 300* OWNER

- Beam Amidships: 10'7" (3.23 m)
 - Bridge Clearance w/Hardtop: 9'9" (2.97 m)
 - Center Line Length: 30'6" (9.30 m)
 - Length Overall (w/pulpit): 32'7" (9.93 m)
 - Cockpit Depth: 29" (0.74 m)
 - Cockpit Square Footage: 74 sq. ft. (6.9 m²)
- Hull Draft: 23" (0.58 m)
 - Maximum HP: 700 (522 kW)
 - Outboard Shaft Length: 25" (0.64 m)
 - Standard Fuel Capacity: 300 gal. (1136 l)
 - Transom Width: 9'6" (2.90 m)
 - Weight w/o Engines: 8221 lb. (3729 kg)

For detailed specifications see page 56.

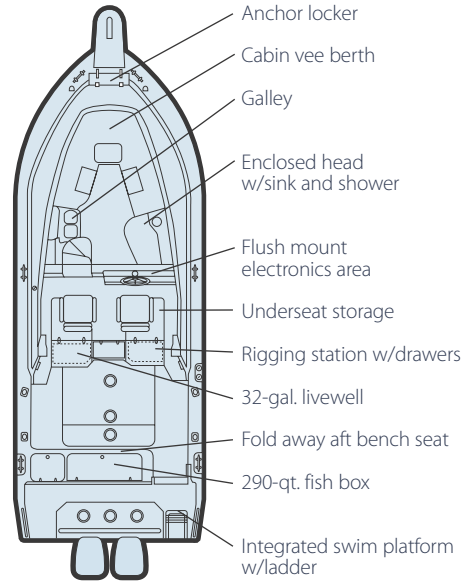

Marlin 300

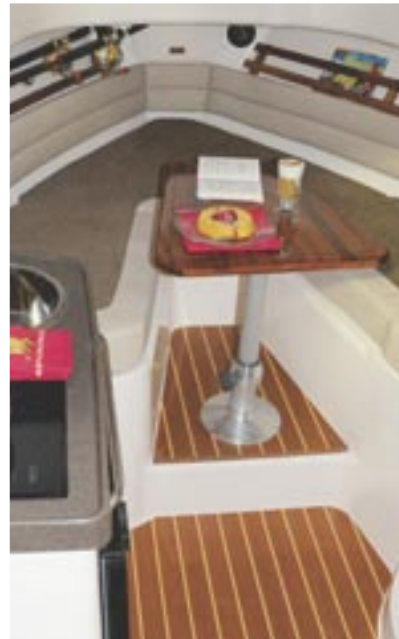

Cockpit forward showing helm area and seating

Fold away bench seat, transom door, fish box and lift out box

Cabin interior with optional flat screen TV and DVD player

Aft double berth with storage nets

Cabin interior featuring galley, teak dinette table and teak and holly sole and enclosed head

50th anniversary edition

Express 305

30' EXPRESS CABIN

"I like the center steering, huge windshield, hidden electronic box (a real '10'), the hardtop hatch, the one-piece bow rail and a fish box that never ends. My 305 is great for days fishing and laughing with my friends, kids and grandchildren."

—RON SCHAEFER, EDGEWATER, MD EXPRESS 305 OWNER

- | | |
|--|---|
| Beam Amidships: 10'7" (3.23 m) | Hull Draft: 23" (0.58 m) |
| Bridge Clearance w/Hardtop: 9'9" (2.97 m) | Maximum HP: 700 (522 kW) |
| Center Line Length: 30'6" (9.30 m) | Outboard Shaft Length: 25" (0.64 m) |
| Length Overall (w/pulpit): 32'7" (9.93 m) | Standard Fuel Capacity: 290 gal. (1098 l) |
| Cockpit Depth: 28" (0.71 m) | Transom Width: 9'6" (2.90 m) |
| Cockpit Square Footage: 63 sq. ft. (5.9 m ²) | Weight w/o Engines: 8850 lb. (4014 kg) |

For detailed specifications see page 56-57.

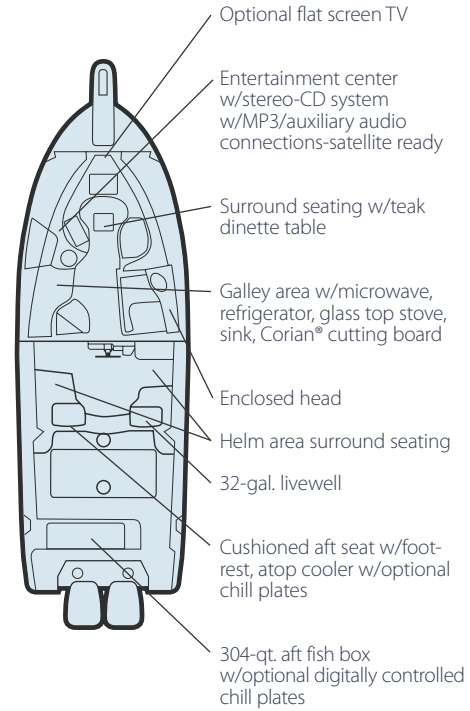

Express 305



Helm station with electromechanically operated lockable electronics enclosure



Cockpit forward with transom door



Cabin interior featuring galley, teak dinette table, teak and holly sole



Lockable head enclosure



50th anniversary edition

Bimini 306

30' CENTER CONSOLE

"We love to fish for king mackerel and the 306 is really a great offshore boat. But take the rods off, and it's really family ready, full of creature comforts. With the spacious console and comfortable seats and bow cushions, my wife and three-year-old enjoy great afternoon and evening picnics. Everyone's happy and comfortable the whole time. I always feel safe!"

—BRANDON MALLARD, GEORGETOWN, SC Bimini 306 OWNER

- | | |
|--|---|
| Beam Amidships: 10'7" (3.23 m) | Hull Draft: 21" (0.53 m) |
| Bridge Clearance: 7'3" (2.21 m) | Maximum HP: 700 (522 kW) |
| w/T-top: 9'4" (2.84 m) | Outboard Shaft Length: 25" (0.64 m) |
| Center Line Length: 30'6" (9.30 m) | Standard Fuel Capacity: 290 gal. (1098 l) |
| Cockpit Depth: 27" (0.69 m) | Transom Width: 9'6" (2.90 m) |
| Cockpit Square Footage: 75 sq. ft. (7.0 m ²) | Weight w/o Engines: 6950 lb. (3152 kg) |

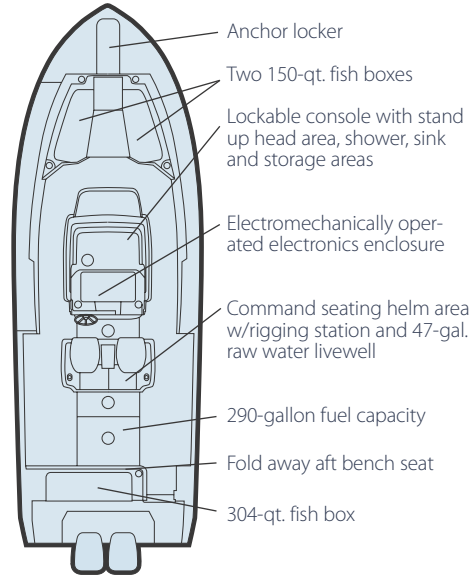

Bimini 306

Shown with optional T-top. For detailed specifications see page 57.



Lockable head enclosure with fold down cover, sink and storage



Helm console with electromechanically operated lockable electronics enclosure



Command seating helm area with two deluxe adjustable sliding chairs and rigging station with freshwater sink, pullout faucet and insulated livewell



Anchor locker with windlass

50th anniversary edition



Tournament 307

30' DUAL CONSOLE

“Customers told us that they wanted a larger, top of the line open cruiser that was super functional and comfortable for any coastal activity—outings, diving, skiing, day trips, exploring, picnicking—as well as being an excellent fishing boat.”

—DAVID NEESE, GRADY-WHITE VICE-PRESIDENT ENGINEERING

- | | |
|--|--|
| Beam Amidships: 10'7" (3.23 m) | Hull Draft: 22" (0.56 m) |
| Bridge Clearance: 6'11" (2.11 m) | Maximum HP: 700 (522 kW) |
| w/Hardtop: 8'10" (2.69 m) | Outboard Shaft Length: 25" (0.64 m) |
| Center Line Length: 30'5" (9.30 m) | Standard Fuel Capacity: 206 gal. (780 l) |
| Cockpit Depth: 27" (0.69 m) | Transom Width: 9'6" (2.90 m) |
| Cockpit Square Footage: 80 sq. ft. (7.4 m ²) | Weight w/o Engines: 7850 lb. (3561 kg) |

Shown with optional hardtop. For detailed specifications see page 57.

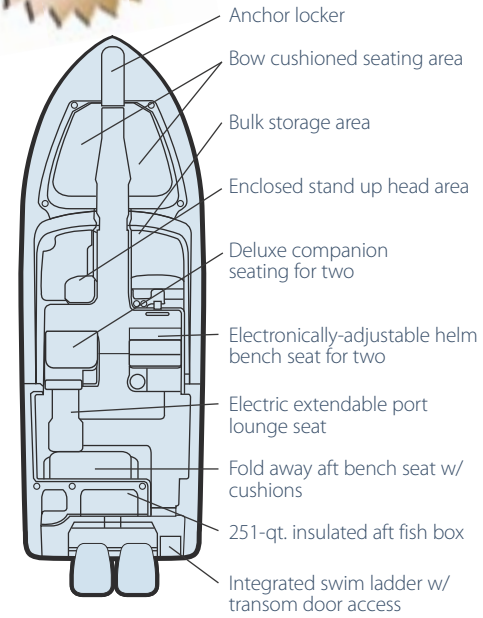

Tournament 307



Deluxe cushioned bow seating with table (doubles as a cockpit area table)



Table doubles as cockpit or bow area table.



Cockpit forward showing companion seating area with electric extendable lounge seating, and wet bar with optional refrigerator, inverter and grill under Corian® countertop



Stand up head area with bulk storage; fold down head cover creates 5' berth.



50th anniversary edition

Express 330

33' EXPRESS CABIN

"We were looking for a boat that would be perfect for completing America's Great Loop, and fell in love with the *Express 330*."

—CHRIS BRANCH AND RUSS OTTERBINE, BOYNE CITY, MI/OLDSMAR, FL

EXPRESS 330 OWNERS

- Beam Amidships: 11'7" (3.53 m)
- Bridge Clearance w/Hardtop: 9'10" (3.00 m)
- Center Line Length: 33'6" (10.21 m)
- Length Overall (w/pulpit): 35'10" (10.92 m)
- Cockpit Depth: 29" (0.74 m)
- Cockpit Square Footage: 80 sq. ft. (7.4 m²)
- Hull Draft: 25" (0.64 m)
- Maximum HP: 700 (522 kW)
- Outboard Shaft Length: 25" (0.64 m)
- Standard Fuel Capacity: 350 gal. (1325 l)
- Transom Width: 10'6" (3.20 m)
- Weight w/o Engines: 10,840 lb. (4917 kg)

Shown with optional 15-ft. outriggers. For detailed specifications see page 58.

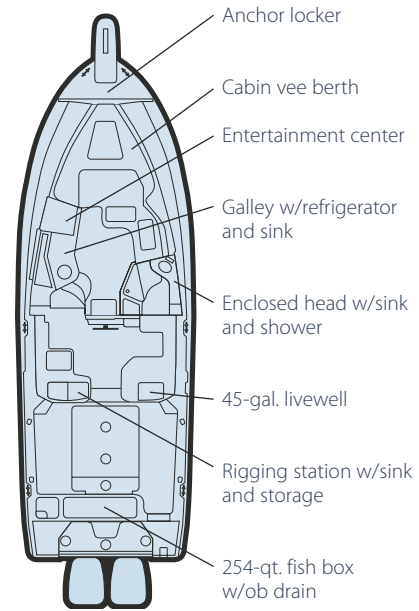

Express 330



Easy access for standard generator



254-qt. aft deck insulated fish box



Port side tackle station and sink



Helm console with electromechanically operated lockable electronics enclosure



50th anniversary edition

Express 330

33' EXPRESS CABIN

“We traveled 4,303 miles over seven weeks on the water completing the Loop. Our 330 had more than enough room for all the supplies and clothes we needed...and we are still speaking!”

—CHRIS BRANCH AND RUSS OTTERBINE, BOYNE CITY, MI/OLDSMAR, FL

EXPRESS 330 OWNERS



“We had wanted to complete America’s Great Loop—the continuous passage of the waterways of the Atlantic Seaboard, through inland rivers, across the Great Lakes, south via more rivers and then around the Gulf of Mexico. We’d begun the adventure in our former boat before hurricanes Charlie, Frances, Ivan and Jeanne interfered. After seeing the *Express 330* at a Fort Lauderdale

show, we knew this was the boat we wanted. The shallow draft gets us through all passageways, we can trailer the boat, the cabin berth layout is great for sleeping, and the storage capacity means we never run of room and aren’t cramped. We love the twin Yamahas for efficiency and ease of use!”



Cabin interior showing access to aft double berth



Helm area surround seating shown with optional Deluxe Platinum helm chair



Starboard helm surround seating (middle cushion area folds down)



Head enclosure with extensible shower faucet



Cabin interior featuring galley with refrigerator and microwave and flat screen 15" LCD TV w/DVD player and audio visual inputs



Cabin interior with teak and holly sole

50th anniversary edition

Canyon 336

33' CENTER CONSOLE

"I've had five boats including large inboards, and the *Canyon 336* is by far the best combination of hull, power and accommodations I have ever experienced. It's perfect whether I am scuba diving, or fishing with my friends, or just enjoying the day on the water with my wife and family. The anchoring system is superb."

-NORM CHAMBERS, GLOUCESTER, MA CANYON 336 OWNER

- | | |
|--|---|
| Beam Amidships: 11'7" (3.53 m) | Hull Draft: 25" (0.64 m) |
| Bridge Clearance: 8' (2.44 m) | Maximum HP: 700 (522 kW) |
| w/T-Top: 9'2" (2.79 m) | Outboard Shaft Length: 25" (0.64 m) |
| Center Line Length: 33'6" (10.21 m) | Standard Fuel Capacity: 350 gal. (1325 l) |
| Cockpit Depth: 29" (0.74 m) | Transom Width: 10'6" (3.20 m) |
| Cockpit Square Footage: 80 sq. ft. (7.4 m ²) | Weight w/o Engines: 9200 lb. (4173 kg) |

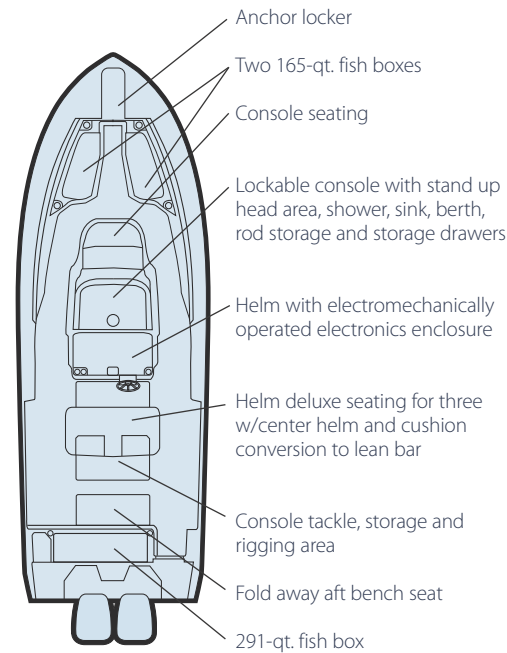

Shown with optional T-top. For detailed specifications see page 58.



Console forward berth

Bow casting area with optional platform insert and cushions

Lockable console interior with stand up head, shower, sink, rod storage, bulk storage and electrical access

Center helm lean bar with three deluxe sliding seats and footrest, electromechanically operated lockable electronics enclosure

Rigging station with freshwater washdown, 104-qt. cooler, tackle drawers, storage, rod holders and knife & pliers holders

Canyon 336

50th anniversary edition

Express 360

36' EXPRESS CABIN

“Our family of five spent a month in the Bahamas on our *Express 360*, and everyone was totally comfortable. We covered over 1500 miles at average cruising speeds of 25-31 mph.”

—SCOTT AND ANJA BRANE, CLEARWATER, FL EXPRESS 360 OWNERS

- | | |
|--|---|
| Beam Amidships: 13'2" (4.01 m) | Outboard Shaft Length: |
| Bridge Clearance w/Hardtop: 10'6" (3.20 m) | Port & Starboard Engines: 25" (0.64 m) |
| Center Line Length: 36'7" (11.15 m) | Center Engine: 30" (0.76 m) |
| Length Overall (w/pulpit): 39'3" (11.96 m) | Standard Fuel Capacity: 370 gal. (1401 l) |
| Cockpit Depth: 28" (0.71 m) | Freshwater Capacity: 65 gal. (246 l) |
| Cockpit Square Footage: 96 sq. ft. (8.9 m ²) | Transom Width: 11'4" (3.45 m) |
| Hull Draft: 29" (0.74 m) | Weight w/o Engines: 14,919 lb. (6767 kg) |
| Maximum HP: 1050 (783 kW) | |

For detailed specifications see page 59.

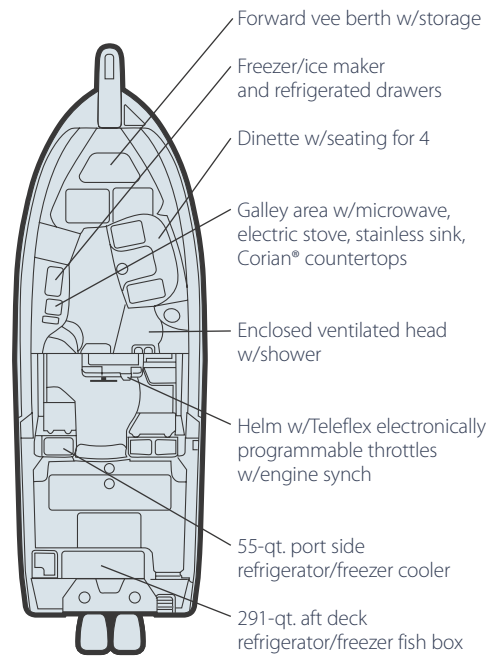

Helm surround seating includes innovative slide-away table, chart/storage area, additional fold away seating and deluxe cushioning.



Helm includes deluxe adjustable seating, power assisted tilt steering, Teleflex electronically programmable throttles with engine synch mode, electromechanically operated electronics enclosure, and easy-access accessory fuse compartment.



Express 360

50th anniversary edition

Express 360

36' EXPRESS CABIN

"We ran the boat everywhere in the islands, sometimes in two-and-a-half to three feet of water. This allowed us entry to so many places that no boat other than the tenders could access."

-SCOTT AND ANJA BRANE, CLEARWATER, FL EXPRESS 360 OWNERS

"We loaded our *Express 360* with tons of food, water, and drinks and headed off for a month in the Bahamas, and didn't need to restock until we reached Nassau. The cockpit coolers are amazing! We can't imagine not having them. From South Seas Resort we went to the Keys and then straight to the Bahamas. We cleared in at Cat Cay and then headed for Chub Cay in the Berry Islands. We made the crossing to Nassau in heavy 6-8 foot seas with 20-25 knot winds. Everyone was fine with the ride. We had a great run to the Exumas, and a most memorable night on the hook at Hawksbill Cay. From there it was Harbor Island and then the Abacos. It sure was hard to come back home!"



Cockpit forward showing 96 sq.-ft. cockpit, helm station with deluxe chair, port and starboard lounge seating



291-quart aft deck refrigerator/freezer fish box (shown) along with 55-quart refrigerator/freezer aft helm port box (not shown), both controlled by digital thermostat. Chill plates are located in the walls of foam insulated boxes, increasing efficiency and greatly reducing the need for ice. Coil configuration and overboard drains keep boxes clean, open and easy to maintain.

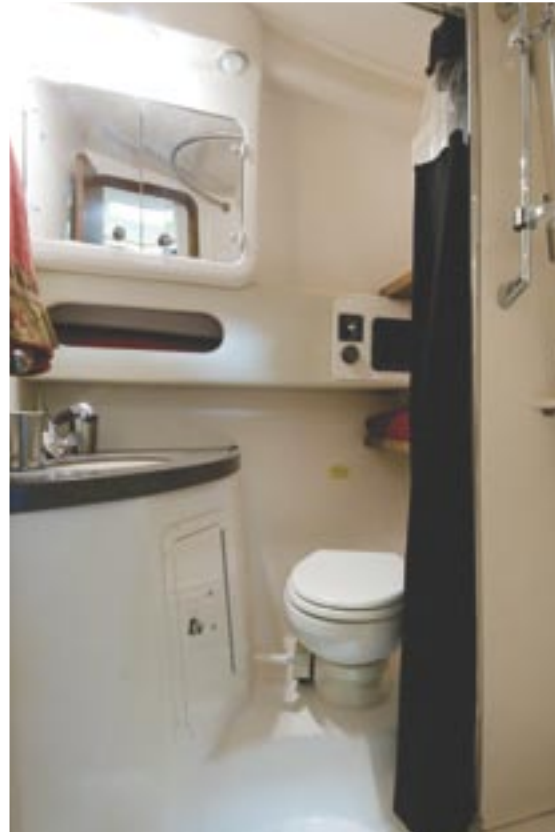

Head/shower area includes sink with Corian® counter surface, separate shower area with curtain, teak grate over shower drain, full length mirror, VacuFlush® head, lighted vanity mirror, teak shelves, storage areas.



Aft berth includes 56" x 84" sleeping area with privacy curtain, teak foot well, teak hanging locker with cedar lining, bulk storage, six rod holders.



Main cabin includes teak and holly sole, seating for four at teak dinette table, variable accent lighting, 16,000 BTU air conditioning with zone cooling, expansive forward berth with storage and privacy curtain, and teak tambour enclosed storage areas.



▲ Hardtop front and side curtains for models 20' and up (330 shown). Drop curtain is available. Frames style and canvas vary per model.



▲ Ivory canvas option (275, 283, 300, 305, 306, 330, 336 & 360)



▲ Hardtop with lockable radio box, spreader lights and rod holders (208)



▲ Hardtop with lockable radio boxes, spreader lights, side rod holders and overhead storage net (optional for cabin models 22'-25', standard for 29'-36')



▲ Center console Bimini top (180, 209, 222)



▲ Bow thruster (290, 300, 305, 306, 330, 336)



▲ Companion bench seat (300 shown)



▲ Jump seat (222)



▲ Companion bench seat (208, 226)



▲ Tournament sleeper seat with storage (185, 205, 225)

Factory options add to your Grady Life.

You'll enjoy your Great Grady Days even more when you accessorize with quality factory options that complement your boating style. For more information on factory options, visit www.gradywhite.com.



▲ Ski pylon



▲ Bow casting platform insert with removable cushions (257, 273, 283, 306, 336)



▲ Walkaround series vista top and side curtains (208, 226/228, 232, 258)



▲ Deluxe I helm chair



▲ Deluxe II helm chair



▲ Deluxe III helm chair



▲ Tournament series vista top and side curtains (185, 205, 225, 275)



▲ Bow pulpit shown with anchor windlass option



▲ Cabin rod racks



▲ Raw water livewell (lean bar option; 209, 222)



Sportsman 180

18' CENTER CONSOLE

Beam Amidships: 7'5" (2.26 m)

Bridge Clearance: 5'7" (1.70 m)

Center Line Length: 17'10" (5.44 m)

Cockpit Depth: 22" (0.56 m)

Cockpit Square Footage: 48 sq. ft. (4.5 m²)

Hull Draft: 15" (0.38 m)

Maximum HP: 150 (112 kW)

Outboard Shaft Length: 25" (0.64 m)

Standard Fuel Capacity: 60 gal. (227 l)

Transom Width: 7'2" (2.18 m)

Weight w/o Engine: 2150 lb. (975 kg)

STANDARD FEATURES

Safety

Automatic bilge pump (1100 GPH) (4164 LPH)
Bow rail - low profile 316 grade stainless steel
Cockpit toe rails
Console grab rail
Fire extinguisher holder
Level flotation
Nonskid fiberglass liner
Self-bailing cockpit w/2 cockpit drains
Stainless steel through-hull fittings

Cockpit & Deck

100% hand laid hull & deck
Casting platform (raised)
Deck hardware - 316 grade stainless steel through-bolted
Drink holders (2)
Factory engine pre-rigging
Fish box - 89-qt. (84.2 l) insulated fish box/storage area w/ob drain
Fuel capacity - 60-gallon (227 l) tank
International lighting
Rod holders (4)
Rod storage racks - horizontal (4)
Rubrail - high density PVC w/stainless steel insert
Seating - bench seat w/reversible back
Seating - aft seats (2)
Spring line cleats
Stern eyes - heavy-duty 316 stainless steel
Storage - aft rigging compartments (2)
Storage - forward anchor locker w/rode storage

Console

Accessory outlet - 12V
Cellular phone holder
Drink holders (2)
Footrest
Ice box - 45-qt. (42.6 l) forward insulated ice box w/ob drain
Rod storage holders - vertical (4)
Seating - forward console seat

Steering - no-feedback mechanical
Steering wheel - 316 grade stainless steel
Storage - lockable console storage
Windshield - Plexiglas windshield w/handrail

OPTIONAL FEATURES

Battery select switch w/extra battery
Bow lifting ring
CE certification package
Cockpit freshwater shower (recessed) - 10-gallon (37.9 l)
High bow rail
Hydraulic trim tabs w/indicator & retractor
Livewell - 11-gallon (41.6 l) insulated raw water livewell
Seating - forward platform cushions
Ski pylon
Steering - hydraulic
Steering - hydraulic tilt
Swim platform w/ladder
Washdown - pressurized raw water w/hose

Canvas Option

Bimini top w/boot



Tournament 185

18' DUAL CONSOLE

Beam Amidships: 7'5" (2.26 m)

Bridge Clearance: 5'1" (1.55 m)

Center Line Length: 17'10" (5.44 m)

Cockpit Depth: 21" (0.53 m)

Cockpit Square Footage: 42 sq. ft. (3.9 m²)

Hull Draft: 15" (0.38 m)

Maximum HP: 150 (112 kW)

Outboard Shaft Length: 25" (0.64 m)

Standard Fuel Capacity: 60 gal. (227 l)

Transom Width: 7'2" (2.18 m)

Weight w/o Engine: 2250 lb. (1021 kg)

STANDARD FEATURES

Safety

Automatic bilge pump (1100 GPH) (4164 LPH)
Level flotation
Bow rail - low profile 316 grade stainless steel
Cockpit toe rails
Companion grab rail
Fire extinguisher holder
Nonskid fiberglass liner
Self-bailing cockpit w/2 cockpit drains
Stainless steel through-hull fittings

Cockpit & Deck

100% hand laid hull & deck

Accessory outlet - 12V
Deck hardware - 316 grade stainless steel through-bolted
Drink holders (9)
Factory engine pre-rigging
Fuel capacity - 60-gallon (227.1 l) tank
Ice box - 48-qt. (45.4 l) aft insulated ice box w/ob drain
Ice box - 38-qt. (36.0 l) starboard bow insulated ice box w/ob drain
International lighting
Rod holders (4)
Rod storage racks - horizontal (4)
Rubrail - high density PVC w/stainless steel insert
Seating - aft seats (2)
Seating - bow cushions
Seating - helm & companion pedestal chairs
Spring line cleats
Steering - no-feedback mechanical
Steering wheel - 316 grade stainless steel
Stern eyes - heavy-duty 316 stainless steel
Storage - forward anchor locker w/rode storage
Storage - lockable console storage compartments (2)
Storage - lockable glove box
Storage - port bow seat compartment
Windshield - walk-through windshield
Windshield wiper (starboard)

OPTIONAL FEATURES

Battery select switch w/extra battery
Bow lifting ring
CE certification package
Cockpit bolsters
Cockpit freshwater shower (recessed) - 10-gallon (37.9 l)
Forward bolsters
Hydraulic trim tabs w/indicator & retractor
Livewell - 12-gallon (45.4 l) insulated raw water livewell
Seating - Deluxe I helm chair
Seating - Deluxe I helm & companion chairs
Seating - port sleeper seat w/storage drawer
Sirius satellite radio system
Ski pylon
Steering - hydraulic
Steering - hydraulic tilt
Stereo/CD system w/MP3/auxiliary audio connections - satellite ready
Sun platform w/cushion
Swim platform w/ladder
Table (bow)
Washdown - pressurized raw water w/hose

Canvas Options

Aft curtain
Bow cover
Vista top & side curtains w/boot



Tournament 205

20' DUAL CONSOLE

Beam Amidships: 8'1" (2.46 m)

Bridge Clearance: 5'7" (1.70 m)

Center Line Length: 20'4" (6.20 m)

Cockpit Depth: 25" (0.64 m)

Cockpit Square Footage: 47 sq. ft. (4.4 m²)

Hull Draft: 15" (0.38 m)

Maximum HP: 250 (187 kW)

Outboard Shaft Length: 25" (0.64 m)

Standard Fuel Capacity: 82 gal. (310 l)

Transom Width: 7'10" (2.39 m)

Weight w/o Engine: 2810 lb. (1275 kg)

STANDARD FEATURES

Safety

Automatic bilge pump (1100 GPH) (4164 LPH)
Basic flotation
Bow rail - low profile 316 grade stainless steel
Cockpit toe rails
Companion grab rail
Fire extinguisher holder
Nonskid fiberglass liner
Self-bailing cockpit w/2 cockpit drains
Stainless steel through-hull fittings

Cockpit & Deck

100% hand laid hull & deck
Accessory outlet - 12V
Cockpit lights
Deck hardware - 316 grade stainless steel through-bolted
Drink holders (8)
Factory engine pre-rigging
Fish box - 64-qt. (60.6 l) aft deck insulated fish box w/ob drain
Fish box - 83-qt. (78.5 l) starboard bow insulated fish box w/ob drain
Fuel capacity - 82-gallon (310.4 l) tank
Head - lockable console head area w/storage nets
International lighting
Rod holders (4)
Rod storage racks - horizontal (6)
Rubrail - high density PVC w/stainless steel insert
Seating - aft seats (2)
Seating - bow cushions
Seating - helm & companion pedestal chairs
Spring line cleats
Steering - no-feedback mechanical
Steering wheel - 316 grade stainless steel
Stern eyes - heavy-duty 316 stainless steel
Storage - forward anchor locker w/rode storage

Storage - lockable console compartment
Storage - port bow seat compartment
Windshield - walk-through windshield
Windshield wiper (starboard)

OPTIONAL FEATURES

Bow lifting ring
CE certification package
Cockpit bolsters
Cockpit freshwater shower (recessed) - 10-gallon (37.9 l)
Forward bolsters
Head - portable
Hydraulic trim tabs w/indicator & retractor
Livewell - 16-gallon (60.6 l) insulated raw water livewell
Seating - Deluxe I helm chair
Seating - Deluxe I helm & companion chairs
Seating - port sleeper seat w/storage drawer
Sirius satellite radio system
Ski pylon
Steering - hydraulic (required w/F200, F225 & F250 engines)
Steering - hydraulic tilt
Stereo/CD system w/MP3/auxiliary audio connections - satellite ready
Sun platform w/cushion
Swim platform w/ladder
Table (bow)
Washdown - pressurized raw water w/hose

Canvas Options
Aft curtain
Bow cover
Drop curtain
Vista top w/side curtains & boot

Visit www.gradywhite.com for the very latest specifications, performance reports, magazine reviews, virtual tours, additional photos and more detailed information on every Grady-White model.



Adventure 208

20' WALKAROUND CABIN

Beam Amidships: 8'1" (2.46 m)

Bridge Clearance: 5'9" (1.75 m)

w/Hardtop: 8' (2.44 m)

Center Line Length: 20'4" (6.20 m)

Cockpit Depth: 25" (0.64 m)

Cockpit Square Footage: 41 sq. ft. (3.8 m²)

Hull Draft: 15" (0.38 m)

Maximum HP: 250 (187 kW)

Outboard Shaft Length: 25" (0.64 m)

Standard Fuel Capacity: 82 gal. (310 l)

Transom Width: 7'10" (2.39 m)

Weight w/o Engine: 2900 lb. (1315 kg)

STANDARD FEATURES

Safety

Automatic bilge pump (1100 GPH) (4164 LPH)
Basic flotation
Bow rail - 316 grade stainless steel
Cockpit toe rails
Companion grab rail
Fold down motorwell bulkhead
Nonskid fiberglass liner
Nonskid recessed walkaround
Self-bailing cockpit w/4 cockpit drains
Stainless steel through-hull fittings

Cabin

Berth - forward vee berth
Cabin light
Forward hatch - low profile acrylic hatch w/screen
Lockable door w/screen & companionway hatch
Rod storage holders (4)
Storage - portable head compartment
Storage - under berth compartments (3)
Windows - opening windows w/screens (2)

Cockpit & Deck

100% hand laid hull & deck
Accessory outlet - 12V (2)
Cockpit lights
Deck hardware - 316 grade stainless steel through-bolted
Drink holders (6)
Factory engine pre-rigging
Fish box - 103-qt. (97.5 l) port insulated fish box w/ob drain
Fish box - 106-qt. (100.3 l) starboard insulated fish box w/ob drain
Footrests (helm & companion)
Fuel capacity - 82-gallon (310.4 l) tank
International lighting
Rod holders (4)
Rod storage racks - horizontal (6)

Rubrail - high density PVC w/stainless steel insert
Seating - aft seats (2)
Seating - helm & companion pedestal chairs
Seating - port & starboard fish box cushions
Spring line cleats
Steering - no-feedback mechanical
Steering wheel - 316 grade stainless steel
Stern eyes - heavy-duty 316 stainless steel
Storage - aft seat lift out boxes (2)
Storage - forward anchor locker w/rode storage
Storage - lockable electronics box
Storage - lockable storage under helm chair
Storage - tackle drawers under companion chair (2)
Storage nets
Windshield
Windshield wiper (starboard)

OPTIONAL FEATURES

Bow lifting ring
Bow pulpit
CE certification package
Cockpit bolsters
Cockpit freshwater shower (recessed) - 10-gallon (37.9 l)
Hardtop w/radio box, spreader lights & side mounted rod holders (4)
Hardtop top-mounted rod holders
Head - portable
Head - portable w/deck pump out
Hydraulic trim tabs w/indicator & retracto
Livewell - 25-gallon (94.6 l) insulated raw water livewell
Seating - companion bench seat
Seating - foredeck cushions
Steering - hydraulic (required w/F200, F225 & F250 engines)
Steering - hydraulic tilt
Swim platform w/ladder
Washdown - pressurized raw water w/hose

Canvas Options

Drop curtain (hardtop or vista top)
Hardtop front & side curtains
Nonskid fiberglass liner
Vista top w/side curtains & boot



Escape 209

20' CENTER CONSOLE

Beam Amidships: 8'1" (2.46 m)

Bridge Clearance: 5'9" (1.75 m)

w/T-top: 7'8" (2.34 m)

Center Line Length: 20'4" (6.20 m)

Cockpit Depth: 25" (0.64 m)

Cockpit Square Footage: 51 sq. ft. (4.7 m²)

Hull Draft: 15" (0.38 m)

Maximum HP: 250 (187 kW)

Outboard Shaft Length: 25" (0.64 m)

Standard Fuel Capacity: 82 gal. (310 l)

Transom Width: 7'10" (2.39 m)

Weight w/o Engine: 2600 lb. (1179 kg)

STANDARD FEATURES

Safety

Automatic bilge pump (1100 GPH) (4164 LPH)
Basic flotation
Bow rail - low profile 316 grade stainless steel
Cockpit toe rails
Console grab rail
Fire extinguisher holder
Fold down motorwell bulkhead
Nonskid fiberglass liner
Self-bailing cockpit w/2 cockpit drains
Stainless steel through-hull fittings

Cockpit & Deck

100% hand laid hull & deck
Casting platform (raised)
Cockpit lights
Deck hardware - 316 grade stainless steel through-bolted
Drink holders (2)
Factory engine pre-rigging
Fish box - 83-qt. (78.52 l) port insulated fish box w/ob drain
Fish box - 120-qt. (113.6 l) starboard insulated fish box w/ob drain
Fuel capacity - 82-gallon (310.4 l) tank
International lighting
Rod holders (4)
Rod storage racks - horizontal (6)
Rubrail - high density PVC w/stainless steel insert
Seating - aft seats (2)
Seating - helm & companion pedestal chairs
Spring line cleats
Stern eyes - heavy-duty 316 stainless steel
Storage - aft rigging compartments (2)
Storage - forward anchor locker w/rode storage

Console

Accessory outlet - 12V (2)
Drink holders (2)
Livewell - 28-gallon (106 l) forward insulated raw water livewell w/ob drain
Rod storage holders - vertical (6)
Seating - forward console seat w/cushion
Steering - no-feedback mechanical
Steering wheel - 316 grade stainless steel
Storage compartment
Windshield - Plexiglas windshield w/handrail

OPTIONAL FEATURES

Bow lifting ring
CE certification package
Cockpit bolsters
Cockpit freshwater shower (recessed) - 10-gallon (37.9 l)
High bow rail
Hydraulic trim tabs w/indicator & retracto
Livewell (lean bar option only) - 23-gallon (87.1 l) insulated raw water livewell w/cushion (in place of standard 28-gallon (106 l) raw water livewell)
Seating - bench seat w/reversible back
Seating - forward platform cushions
Seating - deluxe lean bar w/backrest, footrest, tackle trays, lockable storage & rod holders (4)
Steering - hydraulic (required w/F200, F225 & F250 engines)
Steering - hydraulic tilt
Swim platform w/ladder
T-top w/radio box, dome light, storage net, spreader light & rod holders (4)
Washdown - pressurized raw water w/hose

Canvas Options

Bimini top w/boot
T-top front & side curtains



Fisherman 222

22' CENTER CONSOLE

Beam Amidships: 8' (2.44 m)

Bridge Clearance: 6'2" (1.88 m)

w/T-top: 8' (2.44 m)

Center Line Length: 22'2" (6.76 m)

Cockpit Depth: 25" (0.64 m)

Cockpit Square Footage: 55 sq. ft. (5.1 m²)

Hull Draft: 16" (0.41 m)

Maximum HP: 250 (187 kW)

Outboard Shaft Length: 25" (0.64 m)

Standard Fuel Capacity: 96 gal. (363 l)

Transom Width: 7'11" (2.41 m)

Weight w/o Engine: 3160 lb. (1433 kg)

STANDARD FEATURES

Safety

Automatic bilge pump (1500 GPH) (5678 LPH)
Basic flotation
Bow rail - low profile 316 grade stainless steel
Cockpit toe rails
Console grab rail
Fire extinguisher holder
Fold down motorwell bulkhead
Nonskid fiberglass liner
Self-bailing cockpit w/4 cockpit drains
Stainless steel through-hull fittings

Cockpit & Deck

100% hand laid hull & deck
Casting platform (raised)
Cockpit lights
Compass
Deck hardware - 316 grade stainless steel through-bolted
Drink holder
Factory engine pre-rigging
Fish box - 55-qt. (52 l) port & starboard insulated fish boxes w/ob drain
Fish box - 272-qt. (257.4 l) center insulated fish box w/ob drain
Fuel capacity - 96-gallon (363.4 l) tank
Hydraulic trim tabs w/indicator & retracto
International lighting
Rod holders (4)
Rod storage racks - horizontal (6)
Rubrail - high density PVC w/stainless steel insert
Seating - helm & companion pedestal chairs
Spring line cleats
Stern eyes - heavy-duty 316 stainless steel
Storage - aft deck lift out boxes (2)
Storage - forward anchor locker w/rode storage
Washdown - pressurized raw water w/hose

Console

Accessory outlet - 12V (2)

Drink holders (2)
Head - lockable console w/stand up head area & storage
Rod storage holders - vertical (6)
Seating - forward console seat w/cushion
Steering - hydraulic tilt
Steering wheel - 316 grade stainless steel
Storage - lockable electronics box
Storage - under footrest
Storage nets
Windshield - Plexiglas windshield w/handrail

OPTIONAL FEATURES

Bow lifting ring
Bow pulpit (includes high profile bow rail)
CE certification package
Cockpit bolsters
Cockpit freshwater shower (recessed) - 10-gallon (37.9 l)
Head - portable
Head - portable w/deck pump out
Head - portable w/in-line macerator
Livewell (lean bar option only) - 23-gallon (87.1 l) insulated raw water livewell w/cushion
Outrigger kit - 15-ft (4.6 m) radial T-top mounted
Seating - deluxe lean bar w/footrest, backrest, tackle trays, lockable storage & rod holders (4)
Seating - folding aft jump seats w/cushions (2)
Seating - forward platform cushions
Swim platform w/ladder
T-top w/radio box, dome light, storage net, spreader light, rod holders (4) & outrigger plates

Canvas Options

Bimini top w/boot
T-top front & side curtains



Tournament 225

22' DUAL CONSOLE

Beam Amidships: 8' (2.44 m)

Bridge Clearance: 5'6" (1.68 m)

Center Line Length: 22'2" (6.76 m)

Cockpit Depth: 25" (0.64 m)

Cockpit Square Footage: 49 sq. ft. (4.6 m²)

Hull Draft: 16" (0.41 m)

Maximum HP: 250 (187 kW)

Outboard Shaft Length: 25" (0.64 m)

Standard Fuel Capacity: 96 gal. (363 l)

Transom Width: 7'11" (2.41 m)

Weight w/o Engine: 3450 lb. (1565 kg)

STANDARD FEATURES

Safety

Automatic bilge pump (1500 GPH) (5678 LPH)
Basic flotation
Bow rail - low profile 316 grade stainless steel
Cockpit toe rails

Companion grab rail
Compass
Fire extinguisher holder
Nonskid fiberglass liner
Self-bailing cockpit w/2 cockpit drains
Stainless steel through-hull fittings

Cockpit & Deck

100% hand laid hull & deck
Accessory outlet - 12V (2)
Cockpit freshwater shower (recessed)
Cockpit lights
Deck hardware - 316 grade stainless steel through-bolted
Drink holders (12)
Factory engine pre-rigging
Fish box - 52-qt. (49.2 l) starboard bow insulated fish box w/ob drain
Fish box - 175-qt. (165.6 l) aft insulated fish box w/ob drain
Footrest (helm)
Forward bolsters
Fuel capacity - 96-gallon (363.4 l) tank
Head - lockable console head area w/storage nets
Head - portable
Hydraulic trim tabs w/indicator & retracto
International lighting
Rod holders (4)
Rod storage racks - horizontal (6)
Rubrail - high density PVC w/stainless steel insert
Seating - bow cushions
Seating - fold away aft bench seat w/cushion
Seating - Deluxe I vertically & horizontally adjustable helm & companion chairs
Spring line cleats
Steering - hydraulic tilt
Steering wheel - 316 grade stainless steel
Stern eyes - heavy-duty 316 stainless steel
Storage - 22-gallon (83.3 l) insulated aft storage compartment
Storage - forward anchor locker w/rode storage
Storage - forward bow seat compartment
Storage - lockable console tackle drawers
Storage - lockable electronics box
Storage - port bow seat compartment
Water tank - 10-gallon (37.9 l) freshwater
Windshield - walk-through windshield
Windshield wiper (starboard)

OPTIONAL FEATURES

Bow lifting ring
CE certification package
Cockpit bolsters
Head - portable w/deck pump out
Head - portable w/in-line macerator
Livewell - 22-gallon (83.3 l) insulated raw water livewell w/light, full column distribution inlet & ob drain (1100 GPH pump) (4164 LPH)
Seating - Deluxe II helm chair
Seating - port sleeper seat w/storage drawer
Sirius satellite radio system
Ski pylon
Stereo/CD system w/MP3/auxiliary audio connections - satellite ready
Sun platform w/cushion
Swim platform w/ladder (full width)
Swim platform w/ladder (small port side)
Table (bow)
Washdown - pressurized raw water w/hose

Canvas Options

Aft curtain
Bow cover
Drop curtain
Vista top w/side curtains & boot



Seafarer 226/228

22' WALKAROUND CABIN

Beam Amidships: 8' (2.44 m)

Bridge Clearance: 6'2" (1.88 m)

w/Hardtop: 8'4" (2.54 m)

Center Line Length: 22'2" (6.76 m)

Cockpit Depth: 26" (0.66 m)

Cockpit Square Footage: 49 sq. ft. (4.6 m²)

Hull Draft: 16" (0.41 m)

Maximum HP: 250 (187 kW)

Outboard Shaft Length: 25" (0.64 m)

Standard Fuel Capacity: 125 gal. (473 l)

Transom Width: 7'11" (2.41 m)

Weight w/o Engine:

226 (standard transom): 3385 lb. (1535 kg)

228 (Grady Drive transom): 3510 lb. (1592 kg)

STANDARD FEATURES

Safety

2 automatic bilge pumps (total 2200 GPH) (8328 LPH)
Basic flotation
Bow rail - 316 grade stainless steel
Cockpit toe rails
Companion grab rail
Fold down motorwell bulkhead (226 only)
Nonskid fiberglass liner
Nonskid recessed walkaround
Self-bailing cockpit w/4 cockpit drains
Stainless steel through-hull fittings

Cabin

Berth - forward vee berth
Cabin light
Forward hatch - low profile acrylic hatch w/screen
Lockable door w/screen & companionway hatch
Rod storage holders (4)
Sink
Storage - cabinet
Storage - portable head compartment
Storage - under berth compartments (3)
Windows - opening windows w/screens (2)

Cockpit & Deck

100% hand laid hull & deck
Accessory outlet - 12V (2)
Bait rigging area w/cutting board & drink holders (228 only)
Battery select switch
Cockpit freshwater shower (recessed)
Cockpit lights
Compass
Deck hardware - 316 grade stainless steel through-bolted

Drink holders (6)
Factory engine pre-rigging
Fish box - 72-qt. (68.1 l) aft fish box (228 only)
Fish box - 190-qt. (179.8 l) starboard insulated fish box w/ob drain
Fish box - divided port insulated fish box (80-qt. & 45-qt. sections w/ob drain) (75.7 l & 42.6 l)
Footrests (helm & companion)
Fuel capacity - 125-gallon tank (473.2 l)
Hydraulic trim tabs w/indicator & retracto
International lighting
Rod holders (4)
Rod storage holders - vertical (4) (228 only)
Rod storage racks - horizontal (6)
Rubrail - high density PVC w/stainless steel insert
Seating - aft seats (2)
Seating - helm & companion pedestal chairs
Seating - port & starboard fish box cushions
Spring line cleats
Steering - hydraulic tilt
Steering wheel - 316 grade stainless steel
Stern eyes - heavy-duty 316 stainless steel
Storage - aft lift out boxes
Storage - forward anchor locker w/rode storage
Storage - lockable helm station radio box
Storage - tackle drawers under helm & companion chairs
Storage nets
Water tank - 10-gallon (37.9 l) freshwater
Windshield - ventilated windshield
Windshield wiper (starboard)

OPTIONAL FEATURES

Bow lifting ring
Bow pulpit
CE certification package
Cockpit bolsters
Hardtop w/radio box, storage net, spreader lights & side mounted rod holders (4)
Hardtop top-mounted rod holders
Head - portable
Head - portable w/deck pump out
Head - portable w/in-line macerator
Livewell - 20-gallon (75.7 l) port insulated raw water livewell (226)
Livewell - 20-gallon (75.7 l) aft insulated raw water livewell (228)
Seating - companion bench seat
Seating - foredeck cushions
Swim platform w/ladder
Swim platform w/ladder (full width) (228 only)
Washdown - pressurized raw water w/hose
Windshield wiper (port)

Canvas Options

Drop curtain (hardtop or vista top)
Hardtop front & side curtains
Vista top w/side curtains & boot



Gulfstream 232

23' WALKAROUND CABIN

Beam Amidships: 9'3" (2.82 m)

Bridge Clearance: 6'5" (1.96 m)

w/Hardtop: 8'8" (2.64 m)

Center Line Length: 23'5" (7.14 m)

Cockpit Depth: 27" (0.69 m)

Cockpit Square Footage: 56 sq. ft. (5.2 m²)

Hull Draft: 20" (0.51 m)

Maximum HP: 400 (298 kW)

Outboard Shaft Length

Single: 25" (0.64 m)

Single w/F350: 30" (0.76 m)

Dual: 25" (0.64 m)

Standard Fuel Capacity: 150 gal. (568 l)

Transom Width: 8'10" (2.69 m)

Weight w/o Engine

232S: 4538 lb. (2058 kg)

232D: 4605 lb. (2089 kg)

STANDARD FEATURES

Safety

2 automatic bilge pumps (total 2600 GPH) (9842 LPH)
Basic flotation
Bow rail - 316 grade stainless steel
Cockpit toe rails
Companion grab rail
Nonskid fiberglass liner
Nonskid recessed walkaround
Self-bailing cockpit w/4 cockpit drains
Stainless steel through-hull fittings

Cabin

Berths - 2 berths (upper & lower)
Cabin lights
Forward hatch - low profile acrylic hatch w/screen
Galley - portside galley w/sink
Ice box - insulated ice box w/ob drain
Lockable door w/screen & companionway hatch
Rod storage holders (2)
Storage - aft compartment
Storage - portable head compartment
Storage - under berth compartment
Storage - under sink compartment
Storage nets
Stove - butane
Windows - opening windows w/screens (2)

Cockpit & Deck

100% hand laid hull & deck
Accessory outlet - 12V (2)
Battery select box
Battery select switch
Cockpit freshwater shower (recessed)

Cockpit lights - LED cockpit lighting under gunwales
Compass
Cutting board
Deck hardware - 316 grade stainless steel through-bolted
Drink holders (9)
Factory engine pre-rigging
Fish box - 265-qt. (250.8 l) starboard insulated fish box w/ob drain
Fish box - 297-qt. (281.1 l) aft insulated fish box w/ob drain
Flush mount electronics kit
Footrests - helm & companion (adjustable)
Fuel capacity - 150-gallon (567.8 l) tank
Hydraulic trim tabs w/indicator & retracto
International lighting
Livewell - 36-gallon (136.3 l) port insulated raw water livewell w/light, full column distribution inlet & ob drain (1100 GPH pump) (4164 LPH)
Rod holders (4)
Rod storage racks - horizontal (6)
Rubrail - high density PVC w/stainless steel insert
Seating - Deluxe I helm & companion chairs
Seating - fold away aft bench seat w/cushion
Seating - port livewell cushion
Seating - starboard fish box cushion
Spring line cleats
Steering - hydraulic tilt
Steering wheel - 316 grade stainless steel
Stern eyes - heavy-duty 316 stainless steel
Storage - forward anchor locker w/rode storage
Storage - tackle drawers under helm & companion seat (2)
Storage - tackle trays under helm chair (2)
Washdown - pressurized raw water w/hose
Water tank - 12-gallon (45.4 l) freshwater
Windshield - ventilated windshield
Windshield wipers

OPTIONAL FEATURES

Air conditioner
Anchor windlass (must have bow pulpit)
Bow lifting ring
Bow pulpit
CE certification package
Cockpit bolsters
Cushions - auxiliary berth cushions
Hardtop w/radio box, storage net, spreader lights & side mounted rod holders (4)
Hardtop top-mounted rod holders
Head - marine head w/electric flush & 10-gallon (37.9 l) holding tank
Head - marine head w/macerator, 10-gallon (37.9 l) holding tank & pump out
Head - portable
Head - portable w/deck pump out
Head - portable w/in-line macerator
International AC electrical conversion - 220V 50Hz
Outrigger kit - 15-ft. (4.6 m) radial hardtop mounted (w/hardtop option only)
Rod storage - folding cabin rack (6)
Seating - Deluxe II helm chair
Seating - foredeck cushions
Sirius satellite radio system
Stereo/CD system w/MP3/auxiliary audio connections - satellite ready
Storage - lockable electronics box
Swim platform w/ladder (full width)
Swim platform w/ladder (small port side)
Windshield washer - freshwater (starboard)

Canvas Options

Hardtop drop curtain
Hardtop front & side curtains

Visit www.gradywhite.com for the very latest specifications, performance reports, magazine reviews, virtual tours, additional photos and more detailed information on every Grady-White model.



Advance 257

25' CENTER CONSOLE

Beam Amidships: 8'6" (2.59 m)

Bridge Clearance: 7' (2.13 m)

w/T-top: 8'6" (2.59 m)

Center Line Length: 24'9" (7.54 m)

Cockpit Depth: 27" (0.69 m)

Cockpit Square Footage: 64 sq. ft. (5.9 m²)

Hull Draft: 20" (0.51 m)

Maximum HP: 350 (261 kW)

Outboard Shaft Length

Single: 30" (0.76 m)

Dual: 25" (0.64 m)

Standard Fuel Capacity: 151 gal. (572 l)

Transom Width: 7'10" (2.39 m)

Weight w/o Engine: 4045 lb. (1835 kg)

STANDARD FEATURES

Safety

2 automatic bilge pump (2600 GPH) (9842 LPH)

Basic flotation

Bow rail - low profile 316 grade stainless steel

Cockpit toe rails

Console grab rail

Fire extinguisher holder

Nonskid fiberglass liner

Self-bailing cockpit w/4 cockpit drains

Stainless steel through-hull fittings

Cockpit & Deck

100% hand laid hull & deck

Battery select switch

Cockpit bolsters

Cockpit freshwater shower (recessed)

Cockpit lights - LED cockpit lighting under gunwales

Compass

Cutting board

Deck hardware - 316 grade stainless steel through-bolted

Drink holders (3)

Factory engine pre-rigging

Fish box - 185-qt. (175.1 l) aft insulated fish box

w/ob drain

Fish box - 120-qt. (113.6 l) divided port insulated

fish box w/ob drain

Fish box - 120-qt. (113.6 l) starboard insulated

fish box w/ob drain

Forward bolsters

Fuel capacity - 151-gallon (571.6 l) tank

Hydraulic trim tabs w/indicator & retracter

Integrated outboard mounting system

w/swim platform & ladder



Journey 258

25' WALKAROUND CABIN

Beam Amidships: 8'6" (2.59 m)

Bridge Clearance: 6'6" (1.98 m)

w/Hardtop: 8'8" (2.64 m)

Center Line Length: 24'9" (7.54 m)

Cockpit Depth: 27" (0.69 m)

Cockpit Square Footage: 55 sq. ft. (5.1 m²)

Hull Draft: 20" (0.51 m)

Maximum HP: 350 (261 kW)

Outboard Shaft Length

Single: 30" (0.76 m)

Dual: 25" (0.64 m)

Standard Fuel Capacity: 127 gal. (481 l)

Transom Width: 7'10" (2.39 m)

Weight w/o Engine: 4320 lb. (1960 kg)

STANDARD FEATURES

Safety

2 automatic bilge pumps (total 2600 GPH) (9842 LPH)

Basic flotation

Bow rail - 316 grade stainless steel

Cockpit toe rails

Companion grab rail

Nonskid fiberglass liner

Nonskid recessed walkaround

Self-bailing cockpit w/4 cockpit drains

Stainless steel through-hull fittings

Cabin

Berth - forward vee berth

Cabin light

Carpet

Forward hatch - low profile acrylic hatch

w/screen

Lockable door w/screen & companionway hatch

Rod storage holders (4)

Sink

Storage - portable head compartment

Storage - under berth compartments (5)

Storage nets

Windows - opening windows w/screens (2)

Cockpit & Deck

100% hand laid hull & deck

Accessory outlet - 12V (2)

Battery select switch

Cockpit freshwater shower (recessed)

Cockpit lights - LED cockpit lighting under gunwales

Compass

Cutting board

Deck hardware - 316 grade stainless steel through-bolted

Drink holders (6)

Factory engine pre-rigging

Fish box - 158-qt. (149.5 l) starboard insulated

fish box w/ob drain

Footrest - helm & companion (adjustable)

Fuel capacity - 127-gallon (480.7 l) tank

Hydraulic trim tabs w/indicator & retracter

Ice box - 40-qt. (37.9 l) aft insulated ice box w/ob drain

Integrated outboard mounting system

w/swim platform & ladder

International lighting

Livewell - 34-gallon (128.7 l) port insulated raw water

livewell w/light, full column distribution inlet &

ob drain (1100 GPH pump) (4164 LPH)

Rod holders (6)

Rod storage racks - horizontal (6)

Rubrail - high density PVC w/stainless steel insert

Seating - Deluxe I helm & companion chairs

Seating - fold away aft bench seat w/cushion

Seating - port livewell cushion

Seating - starboard fish box cushion

Spring line cleats

Steering - hydraulic tilt

Steering wheel - 316 grade stainless steel

Stern eyes - heavy-duty 316 stainless steel

Storage - forward anchor locker w/rode storage

Storage - lockable electronics box

Storage - lockable storage under helm seat

Storage - tackle drawer under companion seat

Storage - transom mounted knife &

pliers holder

Transom door - fiberglass

Washdown - pressurized raw water w/hose

Water tank - 10-gallon (37.9 l) freshwater

Windshield - ventilated windshield

Windshield wiper (starboard)

OPTIONAL FEATURES

Air conditioner

Anchor windlass (must have bow pulpit)

Auxiliary fuel capacity - 41-gallon (155.2 l) tank

Cockpit toe rails

Bow pulpit

CE certification package

Cockpit bolsters

Hardtop w/radio box, storage net, spreader

lights & side mounted rod holders (4)

Hardtop top-mounted rod holders

Head - marine head w/macerator, 10-gallon (37.9 l)

holding tank & pump out

Head - portable

Head - portable w/deck pump out

Head - portable w/in-line macerator

International AC electrical conversion - 220V 50Hz

Outrigger kit - 15-ft. (4.6 m) radial hardtop mounted

(w/hardtop option only)

Rod storage - folding cabin rack (4)

Seating - Deluxe II helm chair

Seating - foredeck cushions

Sirius satellite radio system

Stereo/CD system w/MP3/auxiliary audio

connections - satellite ready

Windshield washer - freshwater (starboard)

Windshield wiper (port)

Canvas Options

Drop curtain (hardtop or vista top)

Cockpit freshwater shower (recessed)

Vista top w/side curtains & boot



Chase 273

27' CENTER CONSOLE

Beam Amidships: 8'6" (2.59 m)

Bridge Clearance: 6'9" (2.06 m)

w/T-top: 8'3" (2.51 m)

Center Line Length: 26'11" (8.20 m)

Cockpit Depth: 27" (0.69 m)

Cockpit Area: 65 sq. ft. (6.0 m²)

Hull Draft: 20" (0.51 m)

Maximum HP: 500 (373 kW)

Outboard Shaft Length

Single: 30" (0.76 m)

Dual: 25" (0.64 m)

Standard Fuel Capacity: 205 gal. (776 l)

Transom Width: 7'10" (2.39 m)

Weight w/o Engine: 4843 lb. (2197 kg)

STANDARD FEATURES

Safety

2 automatic bilge pumps (2600 GPH) (9842 LPH)

Basic flotation

Bow rail - low profile 316 grade stainless steel

Cockpit toe rails

Fire extinguisher holder

Nonskid fiberglass liner

Self-bailing cockpit w/4 cockpit drains

Stainless steel through-hull fittings

Cockpit & Deck

100% hand laid hull & deck

Anchor windlass wiring

Battery select switch

Cockpit bolsters

Cockpit freshwater shower (recessed)

Cockpit lights - LED cockpit lighting under gunwales

Compass

Cutting board

Deck hardware - 316 grade stainless steel

through-bolted

Drink holders (4)

Factory engine pre-rigging

Fish box - 104-qt. (98.4 l) port insulated fish box

w/ob drain

Fish box - 104-qt. (98.4 l) starboard insulated fish box

w/ob drain

Fish box - 185-qt. (175.1 l) aft insulated fish box

w/ob drain

Forward bolsters

Fuel capacity - 205-gallon (776.0 l) tank

Hydraulic trim tabs w/indicator & retracter

Integrated outboard mounting system

w/swim platform & ladder

International lighting

Livewell - 32-gallon (121.1 l) aft insulated raw water livewell w/light, full column distribution inlet & ob drain (1100 GPH pump) (4164 LPH)

Rod holders (4)

Rod storage racks - lockable horizontal (6)

Rubrail - high density PVC w/stainless steel insert

Seating - deluxe lean bar w/footrest, backrest,

tackle trays, lockable storage, 4 rod holders

& removable 94-qt. (89 l) cooler

Seating - fold away aft bench seat w/cushion

Seating - forward platform cushions

Spring line cleats

Stern eyes - heavy-duty 316 stainless steel

Storage - forward anchor locker w/rode storage

Transom door - fiberglass

Washdown - pressurized raw water w/hose

Water tank - 20-gallon (75.7 l) freshwater

Console

Accessory outlet - 12V (2)

Console ventilator

Drink holders (2)

Head - lockable console w/stand up head area,

sink, bulk storage & drawers

Seating - molded forward console seat

w/cushion

Steering - hydraulic tilt

Steering wheel - 316 grade stainless steel

Storage - electro-mechanically operated

electronics enclosure

Windshield - Plexiglas windshield w/handrail

OPTIONAL FEATURES

Anchor windlass

Bow lifting ring

Bow pulpit (includes high profile bow rail)

Castling platform insert w/cushions

CE certification package

Head - marine head w/electric flush (10-gallon) (37.9 l)

Head - marine head w/macerator, 10-gallon (37.9 l)

holding tank & pump out

Head - portable

Head - portable w/deck pump out

Head - portable w/in-line macerator

Outrigger kit - 15-ft. (4.6 m) radial T-top mounted

(w/T-top option only)

Sirius satellite radio system

Stereo/CD system w/MP3/auxiliary audio

connections - satellite ready

T-top w/radio box, radar flat, dome light,

storage net, spreader light, rod holders (4)

& outrigger plates

Table (bow)

Canvas Option

T-top front & side curtains



Tournament 275

27' DUAL CONSOLE

Beam Amidships: 8'6" (2.59 m)

Bridge Clearance: 6'3" (1.91 m)

Bridge Clearance w/Hardtop: 8'6" (2.59 m)

Center Line Length: 26'11" (8.20 m)

Cockpit Depth: 27" (0.69 m)

Cockpit Square Footage: 60 sq. ft. (5.6 m²)

Hull Draft: 20" (0.51 m)

Maximum HP: 500 (373 kW)

Outboard Shaft Length

Single: 30" (0.76 m)

Dual: 25" (0.64 m)

Standard Fuel Capacity: 200 gal. (757 l)

Transom Width: 7'10" (2.39 m)

Weight w/o Engines: 4972 lb. (2255 kg)

STANDARD FEATURES

Safety

2 automatic bilge pumps (2600 GPH) (9842 LPH)

Visit www.gradywhite.com for the very latest specifications, performance reports, magazine reviews, virtual tours, additional photos and more detailed information on every Grady-White model.



Chesapeake 290

29' WALKAROUND CABIN

Beam Amidships: 9'11" (3.02 m)

Bridge Clearance w/Hardtop: 9'9" (2.97 m)

Center Line Length: 28' 6" (8.69 m)

Length Overall (w/bow roller): 29' 9" (9.07 m)

Cockpit Depth: 28" (0.71 m)

Cockpit Square Footage: 56 sq. ft. (5.2 m²)

Hull Draft: 24" (0.6 m)

Maximum HP: 600 hp (448 kW)

Outboard Shaft Length: 25" (0.64 m)

Standard Fuel Capacity: 206 gal. (780 l)

Transom Width: 9'1" (2.76 m)

Weight w/o Engines: 7650 lb. (3470 kg)

STANDARD FEATURES

Safety

2 automatic bilge pumps (total 2600 GPH) (9842 LPH)

Basic flotation

Bow rail - 316 grade stainless steel

Cockpit toe rails

Companion grab rail

Nonskid fiberglass liner

Nonskid recessed walkaround

Self-bailing cockpit w/6 cockpit drains

Stainless steel through-hull fittings

Cabin

Accessory outlet - 12V

Berth - aft double berth

Berth - forward vee berth

Cabin lights

Cabin window curtains

Forward hatch - low profile acrylic hatch w/screen

Galley - port side galley w/sink, Corian™ countertop

Head - enclosed head area w/sink, shower, lamp & marine head

w/macerator, 10-gallon (37.9 l) holding tank & pump out

Lockable door w/screen & companionway hatch

Microwave oven

Mirror

Refrigerator

Storage - galley shelves

Storage nets

Stove - electric glass top

Teak & holly sole

Teak table

Water heater - 6 gallon (22.7 l), 120V

Water tank - 32-gallon (121.1 l) freshwater

Windows - opening windows w/screens (2)

Cockpit & Deck

100% hand laid hull & deck

Accessory outlet - 12V (2)

Anchor windlass wiring

Battery charger system

Battery select switches

Cockpit bolsters

Cockpit freshwater shower (recessed)

Cockpit lights - LED cockpit lighting under gunwales

Compass

Cutting board

Deck hardware - 316 grade stainless steel through-bolted

Dockside power w/galvanic isolator

Drink holders (11)

Factory engine pre-rigging

Fish box - 132-qt. (124.9 l) starboard insulated fish box

w/ob drain

Fish box - 265-qt. (250.8 l) aft insulated fish box

w/ob drain

Footrests - helm & companion (adjustable)

Fuel capacity - 206-gallon (779.8 l) tank

Hardtop w/radio box, storage nets, spreader lights,

rod holders (4) & canvas (canvas available in

navy or ivory)

Hydraulic trim tabs w/indicator & retractor

Integrated outboard mounting system

w/swim platform & ladder

International lighting

Livewell - 35-gallon (132.5 l) insulated raw water

livewell w/light, full column distribution

inlet & ob drain (1100 GPH pump) (4164 LPH)

Rod holders (4)

Rod storage racks - horizontal (6)

Rubrail - high density PVC w/stainless steel insert

Seating - fold away aft bench seat w/cushion

Seating - port & starboard fish box cushions

Seating - Deluxe II vertically & horizontally

adjustable helm & companion chairs

Spring line cleats

Steering - hydraulic tilt

Steering wheel - 316 grade stainless steel

Stern eyes - heavy-duty 316 stainless steel

Storage - forward anchor locker w/rode storage

Storage - lockable storage under helm seat

Storage - tackle drawers under companion seat (2)

Transducer mounting flats

Transom door - fiberglass

Washdown - pressurized raw water w/hose

Windshield - ventilated windshield

Windshield washer - freshwater (starboard)

Windshield wipers

OPTIONAL FEATURES

Air conditioning - 8000 BTU

Anchor windlass

Galley - port side galley w/sink, Corian™ cutting board

Head - enclosed head area w/sink, shower, lamp &

Vacuflush™ marine head w/10-gallon (37.9 l) holding tank

Lockable door w/screen & companionway hatch

Microwave oven

Mirror

Refrigerator

Rod storage racks (6)

Rod storage - aft berth

Stereo/CD system w/MP3/auxiliary audio

connections - satellite ready

Outrigger kit - 15-ft. (4.6 m) radial hardtop mounted

Storage - galley cabinet & counter

Storage - under berth compartments

Storage nets

Stove - electric glass top

Teak & holly sole

Teak table

Water heater - 6-gallon (22.7 l), 120V

Water tank - 32-gallon (121.1 l) freshwater

Window - aft berth window w/screen

Windows - opening windows w/screens (2)



Marlin 300

30' WALKAROUND CABIN

Beam Amidships: 10'7" (3.23 m)

Bridge Clearance w/Hardtop: 9'9" (2.97 m)

Center Line Length: 30'6" (9.30 m)

Length Overall (w/pulpit): 32'7" (9.93 m)

Cockpit Depth: 29" (0.74 m)

Cockpit Square Footage: 74 sq. ft. (6.9 m²)

Hull Draft: 23" (0.58 m)

Maximum HP: 700 (522 kW)

Outboard Shaft Length: 25" (0.64 m)

Standard Fuel Capacity: 300 gal. (1136 l)

Transom Width: 9'6" (2.90 m)

Weight w/o Engines: 8221 lb. (3729 kg)

STANDARD FEATURES

Safety

2 automatic bilge pumps (total 2600 GPH) (9842 LPH)

Basic flotation

Bow rail - 316 grade stainless steel

Cockpit toe rails

Companion grab rail

Nonskid fiberglass liner

Nonskid recessed walkaround

Self-bailing cockpit w/4 cockpit drains

Stainless steel through-hull fittings

Cabin

Accessory outlet - 12V

Berth - aft double berth

Berth - forward vee berth

Cabin lights

Cabin window curtains

Forward hatch - low profile acrylic hatch w/screen & shade

Galley - port side galley w/sink & Corian™ cutting board

Head - enclosed head area w/sink, shower, lamp &

Vacuflush™ marine head w/10-gallon (37.9 l) holding tank

Lockable door w/screen & companionway hatch

Microwave oven

Mirror

Refrigerator

Rod storage racks (6)

Rod storage - aft berth

Stereo/CD system w/MP3/auxiliary audio

connections - satellite ready

Outrigger kit - 15-ft. (4.6 m) radial hardtop mounted

Storage - galley cabinet & counter

Storage - under berth compartments

Storage nets

Stove - electric glass top

Teak & holly sole

Teak table

Water heater - 6-gallon (22.7 l), 120V

Water tank - 32-gallon (121.1 l) freshwater

Window - aft berth window w/screen

Windows - opening windows w/screens (2)

Cockpit & Deck

100% hand laid hull & deck

Accessory outlet - 12V (2)

Anchor windlass w/remote switches at

helm & windlass

Batteries (4)

Battery charger system

Battery select switch

Bow pulpit w/roller

Cockpit bolsters

Cockpit freshwater shower (recessed)

Cockpit lights - LED cockpit lighting

under gunwales

Compass

Deck hardware - 316 grade stainless steel

through-bolted

Dockside power w/galvanic isolator

Drink holders (9)

Factory engine pre-rigging

Fighting chair reinforcement

Fish box - 290-qt. (274.4 l) aft insulated

fish box w/ob drain

Flush mount electronics kit

Footrests - helm & companion (adjustable)

Freshwater level indicator

Fuel capacity - 300 gallons (150-gallon tank,

150-gallon tank) (1135 l)

Hardtop w/radio box, storage nets,

spreader lights, rod holders (4) &

canvas (canvas available in navy or ivory)

Hydraulic trim tabs w/indicator & retractor

Integrated outboard mounting system

w/swim platform & ladder

International lighting

Livewell - 32-gallon (121.1 l) insulated raw water

livewell w/light, full column distribution

inlet & ob drain (1100 GPH pump) (4164 LPH)

Rigging station behind helm chair

w/freshwater sink, insulated bait box

w/ob drain & lockable drawers

Rod holders (4)

Rod storage racks - horizontal (6)

Rubrail - high density PVC w/stainless steel insert

Seating - fold away aft bench seat w/cushion

Seating - foredeck cushions

Seating - port fish box cushion

Seating - starboard tackle station cushion

Seating - Deluxe II vertically & horizontally

adjustable helm & companion chairs

Spring line cleats

Steering - hydraulic tilt

Steering wheel - 316 grade stainless steel

Stern eyes - heavy-duty 316 stainless steel

Storage - aft deck lift out box

Storage - forward anchor locker

w/rode storage

Storage - lockable electronics box

Storage - lockable storage under helm &

companion seats

Storage - under step compartment

Storage - aft berth

Transom door - fiberglass

Washdown - pressurized raw water w/hose

Windshield - ventilated windshield

Windshield washer - freshwater (starboard)

Windshield wipers

OPTIONAL FEATURES

Air conditioning - 7000 BTU

Bow thruster

CE certification package

Flat screen TV w/DVD player & audio visual inputs

Generator - 4kW diesel, 12-gallon (45.4 l) fuel capacity

Lockable door w/screen & companionway hatch

Hardtop top-mounted rod holders

International AC electrical conversion - 220V 50Hz

Outrigger kit - 15-ft. (4.6 m) radial hardtop mounted

Outrigger kit - 24-ft. (7.3 m) Lee Pro Series (lay out)

Rod storage - folding cabin rack (4)

Seating - companion bench seat

Seating - Deluxe III helm chair w/flip-up bolster

Sirius satellite radio system

Steering - power assist (standard w/TF350 pkg)

Storage - lockable electronics box



Express 305

30' EXPRESS CABIN

Beam Amidships: 10'7" (3.23 m)

Bridge Clearance w/Hardtop: 9'9" (2.97 m)

Visit www.gradywhite.com for the very latest specifications, performance reports, magazine reviews, virtual tours, additional photos and more detailed information on every Grady-White model.



Express 330

33' EXPRESS CABIN

Beam Amidships: 11'7" (3.53 m)

Bridge Clearance w/Hardtop: 9'10" (3.00 m)

Center Line Length: 33'6" (10.21 m)

Length Overall (w/pulpit): 35'10" (10.92 m)

Cockpit Depth: 29" (0.74 m)

Cockpit Square Footage: 80 sq. ft. (7.4 m²)

Hull Draft: 25" (0.64 m)

Maximum HP: 700 (522 kW)

Outboard Shaft Length: 25" (0.64 m)

Standard Fuel Capacity: 350 gal. (1325 l)

Transom Width: 10'6" (3.20 m)

Weight w/o Engines: 10,840 lb. (4917 kg)

STANDARD FEATURES

Safety

2 automatic bilge pumps (total 3000 GPH) (11,356 LPH)
Basic flotation
Bow rail - 316 grade stainless steel
Cockpit toe rails
Companion grab rail
Nonskid fiberglass liner
Self-bailing cockpit w/4 cockpit drains
Stainless steel through-hull fittings

Cabin

Accessory outlet - 12V
Air conditioning - 12,000 BTU
Berth - aft double berth
Berth - forward vee berth
Cabin lights
Flat screen 15" LCD TV w/DVD player & audio visual inputs
Forward hatch - low profile acrylic hatches w/retractable screen & shade (2)
Forward hatch curtains
Galley - port side galley w/sink & Corian® cutting board
Head - enclosed ventilated head area w/sink, shower, lamps, storage cabinet & VacuFlush® marine head w/10-gallon (37.9 l) holding tank
Lockable door w/screen & companionway hatch
Microwave oven
Mirrors
Refrigerator
Rod storage racks

Stereo/CD system w/MP3/auxiliary audio connections - satellite ready
Storage - galley cabinets
Storage - under berth compartments
Storage nets
Stove - electric glass top
Teak & holly sole
Teak table
Water heater - 6-gallon (22.7 l), 120V
Water tank - 44-gallon (166.6 l) freshwater

Cockpit & Deck

100% hand laid hull & deck
Accessory outlet - 12V (2)
Anchor windlass w/remote switches at helm & windlass
Batteries (4)
Battery charger system
Battery select switch
Bow pulpit w/roller
Cockpit bolsters
Cockpit freshwater shower (recessed)
Cockpit lights - LED cockpit lighting under gunwales
Cockpit lights - LED lighting at helm
Compass
Cooler - 56-qt. (53 l) port helm seat cooler
Deck hardware - 316 grade stainless steel through-bolted
Deluxe helm chair
Dockside power w/galvanic isolator
Drink holders (8)
Factory engine pre-rigging
Fighting chair reinforcement
Fish box - 254-qt. (240.4 l) aft insulated fish box w/ob drain
Footrest - helm (adjustable)
Fuel capacity - 350 gallons (150-gallon tank, 200-gallon tank) (1325 l)
Generator - 4kW diesel, 13-gallon (49.2 l) fuel capacity
Hardtop w/radio box, storage net, spreader lights, rod holders (6), low profile acrylic hatch & canvas (canvas available in navy or ivory)
Hydraulic trim tabs w/indicator & retractor
Integrated outboard mounting system w/swim platform & ladder
International lighting
Livewell - 45-gallon (170.3 l) starboard insulated raw water livewell w/light, full column distribution inlet & ob drain (1100 GPH pump) (4164 LPH)
Rigging station w/freshwater sink & pullout faucet
Rod holders - gunwale (4)
Rod storage racks - horizontal (4)
Rubrail - high density PVC w/stainless steel insert
Seating - fold away aft bench seat w/cushion
Seating - helm area surround seat
Seating - vertically & horizontally adjustable deluxe helm chair
Spring line cleats
Steering - hydraulic tilt
Steering wheel - 316 grade stainless steel
Stern eyes - heavy-duty 316 stainless steel
Storage - aft deck lift out box
Storage - electromechanically operated electronics enclosure

Storage - forward anchor locker w/rode storage
Storage - under helm area surround seating
Storage nets
Transom door - fiberglass
Washdown - pressurized raw water w/hose
Windshield - ventilated windshield
Windshield washer - freshwater
Windshield wiper

OPTIONAL FEATURES

Air conditioning - 12,000 BTU at helm
Bow thruster
CE certification package
Freezer - refrigerator/freezer fish box w/digitally controlled thermostat & ob drain
International AC electrical conversion - 220V 50Hz
Outrigger kit - 15-ft. (4.6 m) radial hardtop mounted
Outrigger kit - 24-ft. (7.3 m) Lee Pro Series (lay out)
Seating - Deluxe III helm chair w/flip-up bolster
Seating - Deluxe Platinum vertically & horizontally adjustable helm chair
Steering - power assist (standard w/TF350 pkg)
Sirius satellite radio system



Canyon 336

33' CENTER CONSOLE

Beam Amidships: 11'7" (3.53 m)

Bridge Clearance: 8' (2.44 m)

w/T-Top: 9'2" (2.79 m)

Center Line Length: 33'6" (10.21 m)

Cockpit Depth: 29" (0.74 m)

Cockpit Square Footage: 80 sq. ft. (7.4 m²)

Hull Draft: 25" (0.64 m)

Maximum HP: 700 (522 kW)

Outboard Shaft Length: 25" (0.64 m)

Standard Fuel Capacity: 350 gal. (1325 l)

Transom Width: 10'6" (3.20 m)

Weight w/o Engines: 9200 lb. (4173 kg)

STANDARD FEATURES

Safety

2 automatic bilge pumps (total 3000 GPH) (11356 LPH)
Basic flotation
Bow rail - low profile 316 grade stainless steel
Cockpit toe rails
Console grab rail (2)
Nonskid fiberglass liner
Self-bailing cockpit w/4 cockpit drains
Stainless steel through-hull fittings

Cockpit & Deck

100% hand laid hull & deck
Anchor windlass w/remote switches at helm & windlass
Battery charger
Battery select switch
Cleats - flushmount (pop up)
Cockpit bolsters
Cockpit freshwater shower (recessed)
Cockpit lights - LED cockpit lighting under gunwales
Cutting boards (2)
Deck hardware - 316 grade stainless steel through-bolted
Dockside power w/galvanic isolator
Drink holders (7)
Factory engine pre-rigging
Fish box - 165-qt. (156.1 l) port & starboard insulated fish boxes w/ob drain
Fish box - 291-qt. (275.4 l) aft insulated fish box w/ob drain
Forward bolsters
Fuel capacity - 350 gallons (1325 l)
Hydraulic trim tabs w/indicator & retractor
Integrated outboard mounting system w/swim platform & ladder
International lighting
Rod storage racks - horizontal (6)
Rubrail - high density PVC w/stainless steel insert

Seating - fold away aft bench seat w/cushion
Seating - forward platform cushions
Stern eyes - heavy-duty 316 stainless steel
Storage - aft transom drop in box
Storage - forward anchor locker w/rode storage
Storage nets
Transom door - fiberglass
Washdown - pressurized raw water w/hose (2 outlets)
Water tank - 44-gallon (166.6 l) freshwater

Console

Accessory outlet - 12V (2)
Berth
Compass
Console ventilator
Drink holders (3)
Head - lockable console w/stand up head area, shower, sink, bulk storage drawers, VacuFlush® head, 10-gallon (37.9 l) holding tank & pump out, bulk storage
Rod storage - vertical lockable storage for 6 rods
Seating - molded forward console seat w/cushion (3)
Steering - hydraulic tilt
Steering wheel - 316 grade stainless steel
Stereo/CD system w/MP3/auxiliary audio connections - satellite ready
Storage - electromechanically operated electronics enclosure
Storage - lockable acrylic console door
Storage pockets (3)
Storage - under footrest
Window - opening window w/screen
Windshield - glass windshield
Windshield wiper

Deluxe Lean Bar

Knife & pliers holders (2)
Livewell - 45-gallon (170.3 l) insulated raw water livewell w/light, full column distribution inlet & ob drain (1100 GPH pump) (4164 LPH)
Rigging station - lean bar station w/freshwater washdown & 104-qt. (98.4 l) cooler
Rod holders (6)
Seating - deluxe lean bar w/footrest, deluxe sliding chairs w/flip-up bolsters (3)
Storage - lockable tackle drawers
Storage - lockable bulk storage

OPTIONAL FEATURES

Air conditioning in console w/2 outlets at helm (6,000 BTU)
Bow thruster
Casting platform insert w/cushions
CE certification package
Freezer - refrigerator/freezer fish box w/digitally controlled thermostat & ob drain
Generator - 4kW diesel, 12-gal. (45.4 l) fuel capacity
International AC electrical conversion - 220V 50Hz
Livewell - 26-gal. (98.4 l) livewell (replaces lean bar cooler)
Microwave
Outrigger kit - 15-ft. (4.6 m) radial T-top mounted (w/T-top option only)
Sirius satellite radio system
Steering - power assist (standard w/TF 350 package)
Table (bow)
T-top (fiberglass) w/radio box, antenna flats, dome light, storage net, fore/aft spreader lights & rod holders (5) & stereo speakers (2)
Water heater (6 gallons) (22.7 l)

Canvas Options

T-top front & side curtains (canvas available in ivory or navy)



Express 360

36' EXPRESS CABIN

Beam Amidships: 13'2" (4.01 m)

Bridge Clearance w/Hardtop: 10'6" (3.20 m)

Center Line Length: 36'7" (11.15 m)

Length Overall (w/pulpit): 39'3" (11.96 m)

Cockpit Depth: 28" (0.71 m)

Cockpit Square Footage: 96 sq. ft. (8.9 m²)

Hull Draft: 29" (0.74 m)

Maximum HP: 1050 (783 kW)

Outboard Shaft Length:

Port & Starboard Engines: 25" (0.64 m)

Center Engine: 30" (0.76 m)

Standard Fuel Capacity: 370 gal. (1401 l)

Freshwater Capacity: 65 gal. (246 l)

Transom Width: 11'4" (3.45 m)

Weight w/o Engines: 14,919 lb. (6767 kg)

STANDARD FEATURES

Safety

2 automatic bilge pumps (total 3000 GPH) (11,356 LPH)
Basic flotation
Bow rail - 316 grade stainless steel
Cockpit toe rails
Companion hand rails
Fire extinguisher mounting equipment
Nonskid fiberglass surfaces
Self-bailing cockpit w/4 cockpit drains
Stainless steel through-hull fittings

Cabin

Accessory outlet - 12V
Accessory outlet - 110V duplex outlet (3)
Air conditioning - 16,000 BTU
Berth - aft double berth w/mattress
Berth - forward vee berth w/mattress
Cabin lights - variable lighting, reading lamps & illuminated etched glass in teak bulkhead
Cable TV inlet
Corian® shelf w/drink holders behind dinette
Flat screen 15" LCD TV w/DVD player & audio visual inputs
Forward hatch - low profile acrylic hatches w/retractable screen & shade (2)
Lockable sliding door w/separate screen door
Mirror
Rod storage racks - aft berth (6)
Seating - premium vinyl surface dinette surround cushions
Sirius satellite service

Skylight
Stereo/CD system - MP3/auxiliary audio connections
Storage - dinette storage cabinet w/teak tambour door
Storage - molded-in fiberglass under berth compartments (3)
Storage - molded-in fiberglass storage under dinette
Storage - shelves
Storage - stacked teak drawers under forward berth (2)
Teak cedar-lined pullout hanging closet
Teak dinette table w/adjustable stainless steel base (seats 4)
Teak & holly sole
Water heater - 11-gallon (41.6 l) 120V
Water level indicator gauge
Water tank - 54-gallon (204.4 l) freshwater

Galley

Electric glass top stove w/2 burners
Freezer drawer w/ice maker
Microwave oven - 1.1 cu. ft. (0.03 m³) convection microwave oven - 120V 60Hz
Refrigerator drawer
Stainless steel sinks w/Corian® counter surface (2)
Storage - fiberglass cabinet w/teak & tambour doors over galley
Storage - premium teak drawers & doors under galley
Teak pullout trash container area

Head

Enclosed ventilated head area
Full length mirror located on door
Shower area w/deluxe curtain & teak floor drain cover
Sink w/Corian® counter surface
Storage - fiberglass cabinet below sink
Storage - teak shelves (2)
VacuFlush® marine head w/18-gallon (68.1 l) holding tank
Vanity w/mirror & lamps

Cockpit & Deck

100% hand laid hull & deck
Accessory outlet - 12V (2)
Accessory outlet - 110V outlet
Air conditioning - 16,000 BTU at helm
Anchor windlass w/chain & rode w/remote switches at helm & windlass
Bow pulpit w/roller
Bow thruster - Lewmar 18STT 4.5 kW/6.0 HP
Cleats - 316 stainless steel 10-inch (25.4 cm) through-bolted (6)
Cockpit bolsters
Cockpit freshwater shower (recessed) (2)
Cockpit lights - LED cockpit lighting under gunwales
Cockpit lights - LED lighting at helm
Compass w/light
Cooler - 55-qt. (52.0 l) port side refrigerator/freezer cooler w/digitally controlled thermostat & ob drain

Deck hardware - 316 grade stainless steel through-bolted
Dockside water inlet
Drink holders (10)
Fighting chair reinforcement area
Fish box - 291-qt. (275.4 l) aft refrigerator/freezer fish box w/digitally controlled thermostat & ob drain
Footrest - helm (adjustable)
Fuel capacity - 370 gallons (190-gallon tank, 180-gallon tank) (1401 l)
Generator - 8 kW diesel, 23-gallon (87.1 l) fuel capacity
Hardtop w/storage net, recessed spreader lights, recessed stereo speakers, rod holders (6 horizontal, 6 vertical), 2 low profile acrylic hatches & canvas (canvas available in navy or ivory)
Hydraulic trim tabs (recessed) w/indicator & retractor
Integrated outboard mounting system w/swim platform & stainless steel telescoping ladder
International lighting
Livewell - 48-gallon (181.7 l) starboard insulated raw water livewell w/light, full column distribution inlet & ob drain (1100 GPH pump) (4164 LPH)
Rigging station w/freshwater sink, pullout faucet, insulated bait box, knife/pliers/bait rigs holder & lockable drawers (4)

Rod holders - gunwale (4)

Rod storage racks - horizontal (6)

Rubrail - high density PVC w/stainless steel insert

Seating - patented fold away aft bench seat w/cushion

Seating - port lounge seat w/enclosed storage below

Seating - starboard lounge seat w/convertible configurations & hideaway folding table

Seating - Deluxe Platinum vertically & horizontally adjustable helm chair

Steering - hydraulic tilt w/Teleflex power assist

Steering wheel - 15-in. (38.1 cm) 316 grade stainless steel

Stern eyes - heavy-duty 316 stainless steel

Storage - chart storage at helm

Storage - drawers under starboard seat (2)

Storage - electromechanically operated electronics enclosure

Storage - fender storage

Storage - forward anchor locker w/rode storage

Storage - removable transom storage bin

Storage - under helm footrest

Storage net

Transom door - fiberglass

Washdown - pressurized raw water w/hose & remote switch

Windshield - heavy duty welded aluminum

windshield w/electromechanically operated center vent

Windshield washers - freshwater (3)

Windshield wipers - self parking w/heavy-duty pantograph arms w/intermittent & separate controls (3)

Electrical

Batteries (5)
Battery charger system (2)
Battery select switch (3)
Dockside power w/galvanic isolator & 30 amp service outlets w/shore power cords (2)
Factory engine pre-rigging
Teleflex electronic shifter throttles

OPTIONAL FEATURES

CE certification package
International AC electrical conversion - 220V 50Hz
Outrigger kit - 15-ft. (4.6 m) radial hardtop mounted
Outrigger kit - 24-ft. (7.3 m) Lee Pro Series (lay out)

Grady-Built for customer satisfaction with quality, reliability, safety and long term value.

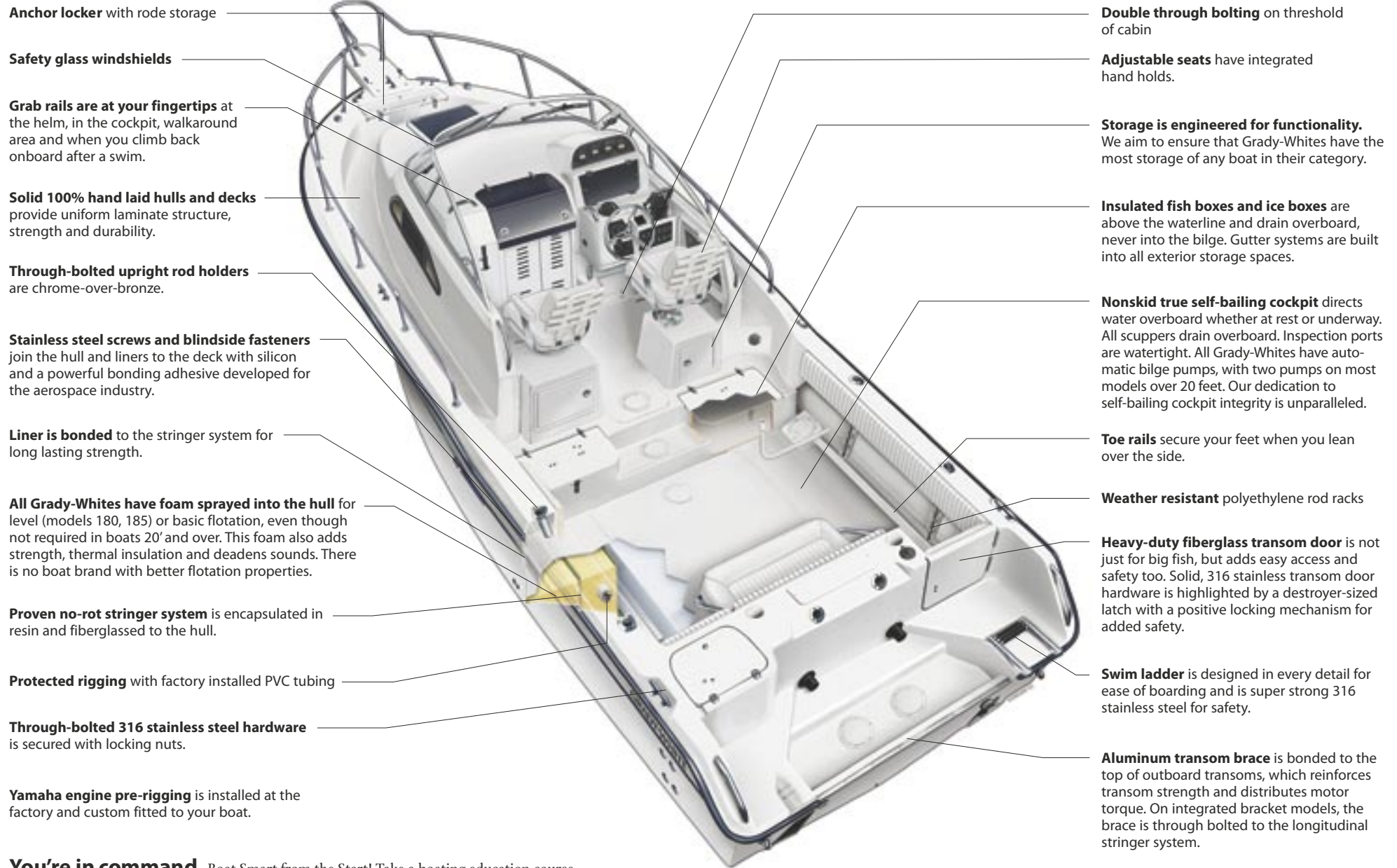

You're in command. Boat Smart from the Start! Take a boating education course, and get a vessel safety check for your boat. For more information, contact: U.S. Coast Guard Auxiliary 877-875-6296/800-368-5647 or www.cgaux.org and U.S. Power Squadrons 888-367-8777 or www.usps.org.

\$5.00 ©2008 Grady-White Boats, Inc. • Grady-White Boats, P.O. Box 1527, Greenville, NC 27835 (252) 752-2111 www.gradywhite.com
Grady-White Boats, Inc. reserves the right to discontinue models, or change prices, specifications, materials, equipment, colors or designs at any time without incurring obligation. Weight and dimensions of models are approximate and may vary. Thanks to: Jerry Imber Photography; Ray Matthews Photography; Bruce Miller Photography; Chip Henderson Photography; Jason Mills, Dewane Frutiger/ASAP Photography; Innovative Images Photography; and especially to Grady-White owners.



The NMMO Certified label on a Grady-White boat is your proof it meets, and often exceeds, industry quality and safety standards.

